

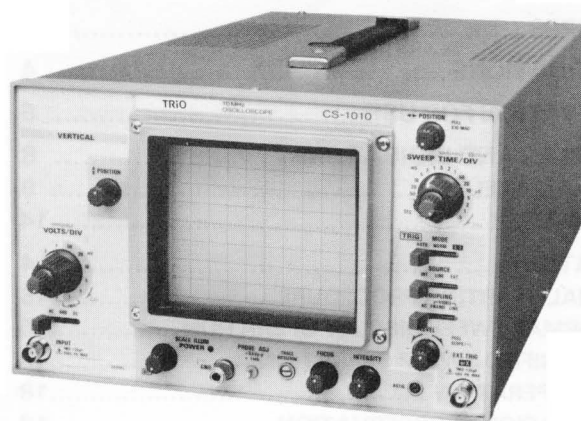
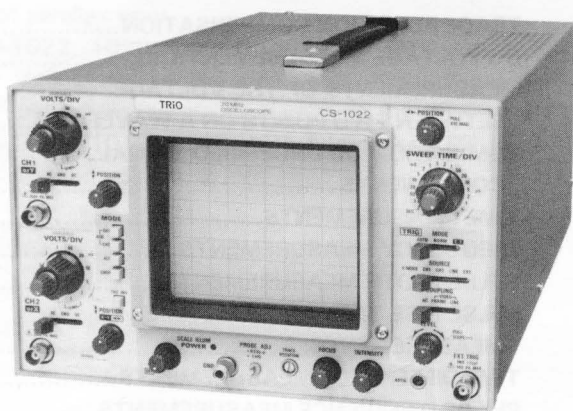
CS-1022, CS-1021, CS-1012

(DUAL TRACE OSCILLOSCOPE)

CS-1020, CS-1010


(SINGLE TRACE OSCILLOSCOPE)

INSTRUCTION MANUAL



SAFETY

Symbol in This Manual

 This symbol indicates where applicable cautionary or other information is to be found.

Power Source

This equipment operates from a power source that does not apply more than 250 V rms between the supply conductors or between either supply conductor and ground. A protective ground connection by way of the grounding conductor in the power cord is essential for safe operation.

Grounding the Product

This equipment is grounded through the grounding conductor of the power cord. To avoid electrical shock, plug the power cord into a properly wired receptacle before connecting to the equipment input or output terminals.

Use the Proper Power Cord

Use only the power cord and connector specified for your product.

Use the Proper Fuse

To avoid fire hazard, use a fuse of the correct type.

Do not Operate in Explosive Atmospheres

To avoid explosion, do not operate this product in an explosive atmosphere.

Do not Remove Cover or Panel

To avoid personal injury, do not remove the cover or panel. Refer servicing to qualified personnel.

Voltage Conversion

If the power source is not applied to your product, contact your dealer. To avoid electrical shock, do not perform the voltage conversion.

CONTENTS

SAFETY	2	TRACE ROTATION COMPENSATION	19
FEATURES	3	DC VOLTAGE MEASUREMENTS	19
SPECIFICATIONS	4	MEASUREMENTS OF THE VOLTAGE	
PREPARATION FOR USE	6	BETWEEN TWO POINTS ON A WAVEFORM	20
CONTROLS AND INDICATORS	8	ELIMINATION OF UNDESIRE SIGNAL	
FRONT PANEL	8	COMPONENTS	20
REAR PANEL	14	TIME MEASUREMENTS	21
OPERATION	14	FREQUENCY MEASUREMENTS	21
INITIAL STARTING PROCEDURE	15	PULSE WIDTH MEASUREMENTS	22
(1) NORMAL SWEEP DISPLAY OPERATION	15	PULSE RISE TIME AND FALLTIME	
(2) MAGNIFIED SWEEP OPERATION	18	MEASUREMENTS	22
(3) X-Y OPERATION	18	TIME DIFFERENCE MEASUREMENTS	23
(4) VIDEO SIGNAL OBSERVATION	18	PHASE DIFFERENCE MEASUREMENTS	24
APPLICATION	19	RELATIVE MEASUREMENTS	24
PROBE COMPENSATION	19	APPLICATION OF X-Y OPERATION	27
		ACCESSORIES	29

Note: This instruction manual is described for five models.
Refer to item applied to your product.

FEATURES

- Vertical axis has high sensitivity and wide bandwidth and especially covers fully specified frequency response at 2mV/div for all models.

CS-1022, 1021 ;

Dual Trace

1mV/div : DC to 10 MHz, -3 dB

2mV/div : DC to 20 MHz, -3 dB

CS-1012 ; Dual Trace

1mV/div : DC to 7 MHz, -3 dB

2mV/div : DC to 10 MHz, -3 dB

CS-1020 ; Single Trace

1mV/div : DC to 10 MHz, -3 dB

2mV/div : DC to 20 MHz, -3 dB

CS-1010 ; Single Trace

1mV/div : DC to 7 MHz, -3 dB

2mV/div : DC to 10 MHz, -3 dB

- Vertical sensitivity range is selectable from 1mV/div to 5V/div with rotary switch continuously.

- Time base permits the high sweep speed.

CS-1022, 1020; 20nsec/div ($\times 10$ MAG)

CS-1021, 1012, 1010; 50nsec/div ($\times 10$ MAG)

- Vertical sensitivity error and sweep rate error are $\pm 3\%$ and accurate measurements are provided.

- The 150 mm rectangular CRT with internal graticule provides high brightness and accurate measurements, free of parallax error.

CS-1022, 1020; domed mesh type CRT with post-deflection acceleration and high brightness phosphors (acceleration voltage; 6 kV).

CS-1021, 1012, 1010; high brightness CRT (acceleration voltage; 2 kV).

- For convenience in making rise time measurements, the 0%, 10%, 90% and 100% levels are marked on the graticule scale of the CRT.

- Trace rotation is electrically adjustable from the front panel.

- By SCALE ILLUM control, the waveform is easy observed in the dark and the photograph of the waveform is easy provided. (Except CS-1021)

- Selectable AUTO FREE RUN function provides sweep without trigger input signal.

- The FRAME-LINE switch provides selection of sync pulse for sweep triggering from small amplitude to large amplitude without adjusting when viewing composite video waveforms.

- For CS-1022, 1021 and 1012, vertical mode automatically provides the trigger signal with TRIG SOURCE and V. MODE switches.

- X-Y operation is easy provided by one-touche.

CS-1022, 1021, 1012; CH1 Y axis,

CH2 X axis

CS-1020, 1010; VERT INPUT Y axis

EXT TRIG INPUT X axis

- CS-1022 and 1012 are provided with CH1 OUTPUT terminal to monitor input signal of CH1.

- CS-1020 and 1010 are provided with VERT OUTPUT terminal to monitor input signal of VERT INPUT.

SPECIFICATIONS

	CS-1022	CS-1021	CS-1012	CS-1020	CS-1010
CRT	150FTM31	150GTM31A	150GTM31A	150FTM31	150GTM31A
Acceleration Voltage	6 kV	2 kV	2 kV	6 kV	2 kV
Display Area	8 × 10 div (1 div = 10 mm)				
Type	Rectangular, with internal graticule				
VERTICAL AXIS	CH1 and CH2			—	
Sensitivity	1 mV/div to 5 V/div, ±3%				
Attenuator	12 steps, 1 mV/div to 5 V/div in 1-2-5 sequence. Vernier control for fully adjustable sensitivity between steps.				
Input Impedance	1 MΩ ±2%, approx. 35pF			1 MΩ ±2%, approx. 32pF	1 MΩ ±2%, approx. 35pF
Frequency Response 2 mV/div to 5 V/div 1 mV/div	DC; DC to 20 MHz, -3 dB AC; 5 Hz to 20 MHz, -3 dB DC; DC to 10 MHz, -3 dB AC; 5 Hz to 10 MHz, -3 dB	DC; DC to 10 MHz, -3 dB AC; 5 Hz to 10 MHz, -3 dB DC; DC to 7 MHz, -3 dB AC; 5 Hz to 7 MHz, -3 dB	DC; DC to 20 MHz, -3 dB AC; 5 Hz to 20 MHz, -3 dB DC; DC to 10 MHz, -3 dB AC; 5 Hz to 10 MHz, -3 dB	DC; DC to 10 MHz, -3 dB AC; 5 Hz to 10 MHz, -3 dB DC; DC to 7 MHz, -3 dB AC; 5 Hz to 7 MHz, -3 dB	DC; DC to 10 MHz, -3 dB AC; 5 Hz to 10 MHz, -3 dB DC; DC to 7 MHz, -3 dB AC; 5 Hz to 7 MHz, -3 dB
Rise Time	17.5 nsec or less (20 MHz) 35 nsec or less (10 MHz)	35 nsec or less (10 MHz) 50 nsec or less (7 MHz)	17.5 nsec or less (20 MHz) 35 nsec or less (10 MHz)	35 nsec or less (10 MHz)	35 nsec or less (10 MHz) 50 nsec or less (7 MHz)
Crosstalk	-40 dB minimum			—	
Operating Modes	CH1; single trace CH2; single trace ADD; CH1 + CH2 added display ALT; two waveforms alternating CHOP; two waveforms chopped			—	
Chop Frequency	Approx. 250 kHz			—	
Channel Polarity	Normal or inverted, CH2 only inverted			—	
Maximum Input voltage	500 Vp-p or 250 V (DC + AC peak)				
Non-Distorted Maximum Amplitude	More than 8 div, DC to 20 MHz	More than 5 div, DC to 20 MHz	More than 6 div, DC to 10 MHz	More than 8 div, DC to 20 MHz	More than 6 div, DC to 10 MHz
HORIZONTAL AXIS	(input thru CH2, × 10 MAG not included)			(× 10 MAG not included)	
Operating Mode	With TRIG MODE switch, X-Y operation is selectable. CH1; Y axis CH2; X axis			With TRIG MODE switch, X-Y operation is selectable. VERT. INPUT; Y axis EXT TRIG INPUT; X axis	
Sensitivity	Same as vertical axis (CH2)			100 mV/div	
Input Impedance	Same as vertical axis (CH2)			1 MΩ ±2%, approx. 32pF	1 MΩ ±2%, approx. 35 pF
Frequency Response	DC; DC to 1 MHz, -3 dB AC; 5 Hz to 1 MHz, -3 dB	DC; DC to 500 kHz, -3 dB AC; 5 Hz to 500 kHz, -3 dB	DC; DC to 1 MHz, -3 dB	DC; DC to 500 kHz, -3 dB	
X-Y Phase Difference	3° or less at 100 kHz	3° or less at 50 kHz	3° or less at 100 kHz	3° or less at 50 kHz	
Maximum Input Voltage	Same as vertical axis (CH2)			50 V (DC + AC peak)	
SWEEP					
Type	NORM	Triggering sweep			
	AUTO	Sweep free runs in absence of trigger			

	CS-1022	CS-1021	CS-1012	CS-1020	CS-1010											
Sweep Time	0.2 μ s/div to 0.5 s/div, \pm 3% in 20 ranges, in 1-2-5 sequence. Vernier control provides fully adjustable sweep time between steps.	0.5 μ s/div to 0.5 s/div, \pm 3% in 19 ranges, in 1-2-5 sequence. Vernier control provides fully adjustable sweep time between steps.		0.2 μ s/div to 0.5 s/div, \pm 3% in 20 ranges, in 1-2-5 sequence. Vernier control provides fully adjustable sweep time between steps.	0.5 μ s/div to 0.5 s/div, \pm 3% in 19 ranges, in 1-2-5 sequence. Vernier control provides fully adjustable sweep time between steps.											
Sweep Magnification	\times 10 (ten times) \pm 5%															
Linearity	\pm 3% all ranges, \pm 5% on 0.2 μ s/div range at \times 10 magnification.															
TRIGGERING																
Internal Sync	V. MODE; CH1; CH2; LINE;	Triggered by input signal selected by vertical MODE setting. Triggered by CH1 signal Triggered by CH2 signal Triggered by line voltage		INT; Triggered by vertical input signal LINE; Triggered by line voltage												
External Sync	EXT; Triggered by signal applied to EXT TRIG INPUT jack															
External sync Input Impedance	1 M Ω , \pm 2% approx. 32pF	1 M Ω , \pm 2% approx. 35pF		1 M Ω , \pm 2% approx. 30pF	1 M Ω , \pm 2% approx. 30pF											
Maximum External Trigger Voltage	50 V (DC + AC peak)															
Coupling	AC, VIDEO FRAME, VIDEO LINE															
Tigger Sensitivity																
		FREQ. RANGE	INT	EXT	FREQ. RANGE	INT	EXT	FREQ. RANGE	INT	EXT	FREQ. RANGE	INT	EXT			
	AUTO	20Hz to 20MHz	1div	0.1Vp-p	20Hz to 20MHz	1div	0.2Vp-p	20Hz to 10MHz	1div	0.1Vp-p	20Hz to 20MHz	1div	0.1Vp-p	20Hz to 10MHz	1div	0.1Vp-p
	NORM	10Hz to 20MHz	1div	0.1Vp-p	10Hz to 20MHz	1div	0.2Vp-p	10Hz to 10MHz	1div	0.1Vp-p	10Hz to 20MHz	1div	0.1Vp-p	10Hz to 10MHz	1div	0.1Vp-p
VIDEO	FRAME, LINE	1div	0.1Vp-p	FRAME, LINE	1div	0.2Vp-p	FRAME, LINE	1div	0.1Vp-p	FRAME, LINE	1div	0.1Vp-p	FRAME, LINE	1div	0.1Vp-p	
PROBE ADJ. VOLTAGE	0.5 V, \pm 6%, square wave, positive polarity, approx. 1 kHz															
INTENSITY MODULATION																
Sensitivity	TTL compatible Positive voltage increases brightness. Negative voltage decreases brightness.															
Input Impedance	Approx. 10 k Ω															
Usable Frequency Range	DC to 2 MHz	DC to 1 MHz		DC to 2 MHz	DC to 1 MHz											
Maximum Input Voltage	50 V (DC + AC peak)															
VERTICAL AXIS SIGNAL OUTPUT	CH1 SIGNAL OUTPUT	—	CH1 SIGNAL OUTPUT	VERTICAL SIGNAL OUTPUT												
Output Voltage	Approx. 50mV/div (50 Ω load)	—	Approx. 50 mV/div (50 Ω load)													
Output Impedance	Approx. 50 Ω	—	Approx. 50 Ω													
Frequency Response	100 Hz to 20 MHz, -3 dB (50 Ω load)	—	100 Hz to 10 MHz, -3 dB (50 Ω load)	100 Hz to 20 MHz, -3 dB (50 Ω load)	100 Hz to 10 MHz, -3 dB (50 Ω load)											
TRACE ROTATION	Electrical, adjustable from front panel															
POWER REQUIREMENT	AC 100/120/220/240 V \pm 10% 50/60 Hz															
Power Consumption	Approx. 43 W	Approx. 39 W	Approx. 41W	Approx. 38W	Approx. 36W											
DIMENSIONS																
() dimensions include protrusions from basic outline dimensions.																
	Width	260 mm (260 mm)														
	Height	160 mm (180 mm)														
	Depth	400 mm (460 mm)														

	CS-1022	CS-1021	CS-1012	CS-1020	CS-1010
WEIGHT	Approx. 8.8 kg	Approx. 8.4 kg			Approx. 8.1 kg
ENVIRONMENT					
Operating Temperature and Humidity for Guaranteed Specifications	0°C to 40°C, 85% maximum RH				
Full Operating Temperature and Humidity	0°C to 50°C, 90% maximum RH				
ACCESSORIES					
Probe	2			1	
Instruction Manual	1				
Replacement Fuse 0.8 A	2				
0.5 A	2				

■ Circuit and rating are subject to change without notice due to developments in technology.

PREPARATION FOR USE

SAFETY

Before connecting the instrument to a power source, carefully read the following information, then verify that the proper power cord is used and the proper line fuse is installed for power source. The specified voltage is shown at the left side of the power cord on the rear panel. If the power cord is not applied for specified voltage, there is always a certain amount of danger from electric shock.

Line voltage

This instrument operates using ac-power input voltages that 100/120/220/240 V at frequencies from 50 Hz to 60 Hz.

Power cord

The ground wire of the 3-wire ac power plug places the chassis and housing of the oscilloscope at earth ground. Do not attempt to defeat the ground wire connection or float the oscilloscope; to do so may pose a great safety hazard. The appropriate power cord is supplied by an option that is specified when the instrument is ordered.

The optional power cords are shown as follows in Fig. 1.

Line fuse

The fuse holder is located on the rear panel and contains the line fuse. Verify that the proper fuse is installed by replacing the line fuse.

EQUIPMENT PROTECTION

- Never allow a small spot of high brilliance to remain stationary on the screen for more than a few seconds. The screen may become permanently burned. A spot will occur only when the scope is set up for X-Y operation and no signal is applied. Either reduce the intensity so the spot is barely visible, switch back to normal sweep operation when no signal is applied, or set up the scope for spot blanking.
- Never cover the ventilating holes on the top of the oscilloscope, as this will increase the operating temperature inside the case.
- Never apply more than the maximum rating to the oscilloscope inputs.
 - CS-1022, 1021, 1012; CH1, CH2 INPUT jacks
500 Vp-p or 250 V (dc+ ac peak)
EXT TRIG INPUT and Z AXIS INPUT jacks
50 V (dc+ ac peak)
 - CS-1020, 1010; VERT INPUT jack
500 Vp-p or 250 V (dc+ ac peak)
EXT TRIG INPUT and Z AXIS INPUT jacks
50 V (dc+ ac peak)

Never apply external voltage to the oscilloscope output terminals.
- Always connect a cable from the earth ground (GND) jack of the oscilloscope to the chassis of the equipment under test. Without this caution, the entire current for the equipment under test may be drawn through the probe clip leads under certain circumstances. Such con-

ditions could also pose a safety hazard, which the ground cable will prevent.

5. Always use the probe ground clips for best results. Do not use an external ground wire in lieu of the probe ground clips, as undesired signals may be introduced.
6. Operation adjacent to equipment which produces strong ac magnetic fields should be avoided where possible. This includes such devices as large power supplies, transformers, electric motors, etc., that are often found in an industrial environment. Strong magnetic shields can exceed the practical CRT magnetic shielding limits and result interference and distortion.

7. Probe compensation adjustment matches the probe to the input of the scope. For best results, compensation of probe should be adjusted initially, then the same probe always used with the input of scope. Probe compensation should be readjusted whenever a probe from a different scope is used. (See page 19)
8. Do not depress two or more push-switches of the vertical MODE switch simultaneously. (Except ADD) Damage to instrument may result. (CS-1022, CS-1021, CS-1012)
9. In X-Y operation, do not pull out the PULL×10 MAG switch. If pulled out it, noise may appear on the waveform.






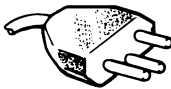
Plug configuration	Power cord and plug type	Factory installed instrument fuse	Line cord plug fuse
	North American 120 volt/60 Hz Rated 15 amp (12 amp max; NEC)	0.8 A, 250 V Fast blow AGC/3AG	None
	Universal Europe 220 volt/50 Hz Rated 16 amp	0.5 A, 250 V Fast blow 5 × 20 mm	None
	U.K. 240 volt/50 Hz Rated 13 amp	0.5 A, 250 V Fast blow 5 × 20 mm	0.5 A Type C
	Australian 240 volt/50 Hz Rated 10 amp	0.5 A, 250 V Fast blow 5 × 20 mm	None
	North American 240 volt/60 Hz Rated 15 amp (12 amp max; NEC)	0.5 A, 250 V Fast blow AGC/3AG	None
	Switzerland 240 volt/50 Hz Rated 10 amp	0.5 A, 250 V Fast blow AGC/3AG 5 × 20 mm	None

Fig. 1 Power Input Voltage Configuration

CONTROLS AND INDICATORS

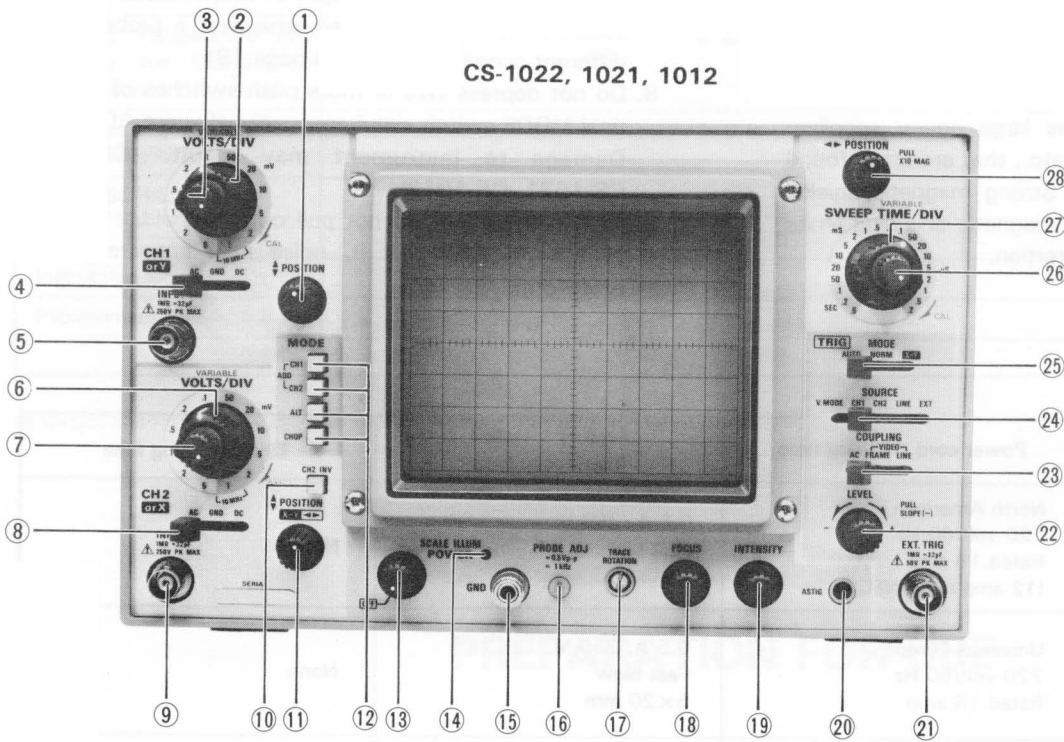


Fig. 2

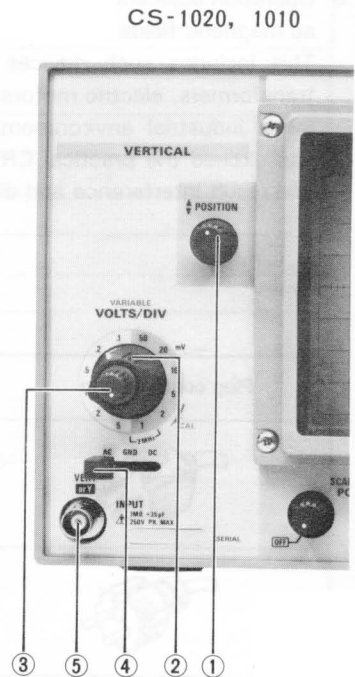


Fig. 3

FRONT PANEL

CS-1022, 1021, 1012	CS-1020, 1010
<p>① POSITION Rotation adjusts vertical position of channel 1 trace. In X-Y operation, rotation adjusts vertical position of display.</p>	<p>① POSITION Rotation adjusts vertical position of trace. In X-Y operation, rotation adjusts vertical position of display.</p>
<p>② VOLTS/DIV Vertical attenuator for channel 1; provides step adjustment of vertical sensitivity. When VARIABLE control ③ is set to CAL, vertical sensitivity is calibrated in 12 steps from 5 V/div to 1 mV/div. For X-Y operation, this control provides step adjustment of vertical sensitivity.</p>	<p>② VOLTS/DIV Vertical attenuator. Coarse adjustment of vertical sensitivity. Vertical sensitivity is calibrated in 12 steps from 5 V/div to 1 mV/div when VARIABLE control ③ is set to CAL. For X-Y operation this provides step adjustment of vertical sensitivity.</p>
<p>③ VARIABLE Control Rotation provides fine control of channel 1 vertical sensitivity. In the fully clockwise (CAL) position, the vertical attenuator is calibrated. For X-Y operation, this control serves as the Y axis attenuation fine adjustment.</p>	<p>③ VARIABLE Control Vertical attenuator adjustment. Fine control of vertical sensitivity. In the fully clockwise (CAL) position, the vertical attenuator is calibrated. For X-Y operation, this control serves as the Y axis attenuation fine adjustment.</p>

CS-1022, 1021, 1012	CS-1020, 1010
<p>④ AC-GND-DC Three-position lever switch which operates as follows: AC: Blocks dc component of channel 1 input signal. GND: Opens signal path and grounds input to vertical amplifier. This provides a zero-signal base line, the position of which can be used as a reference when performing dc measurements. DC: Direct input of ac and dc component of channel 1 input signal.</p>	<p>④ AC-GND-DC Three-position lever switch which operates as follows; AC: Blocks dc component of input signal. GND: Opens signal path and grounds input to vertical amplifier. This provides a zero-signal base line, the position of which can be used as a reference when performing dc measurements. DC: Direct input of ac and dc component of input signal.</p>
<p>⑤ INPUT Jack Vertical input for channel 1 trace. Vertical input for X-Y operation.</p>	<p>⑤ INPUT Jack Vertical input and vertical input for X-Y operation.</p>
<p>⑥ VOLTS/DIV Vertical attenuator for channel 2; provides step adjustment of vertical sensitivity. When VARIABLE control ⑦ is set to CAL, vertical sensitivity is calibrated in 12 steps from 5 V/div to 1 mV/div. In X-Y operation, this control provides step adjustment of horizontal sensitivity.</p>	<p>_____</p>
<p>⑦ VARIABLE Control Rotation provides fine control of channel 2 vertical sensitivity. In the fully clockwise (CAL) position, the vertical attenuator is calibrated. In X-Y operation, this control becomes the fine horizontal gain control.</p>	<p>_____</p>
<p>⑧ AC-GND-DC Three-position lever switch which operates as follows: AC: Blocks dc component of channel 2 input signal. GND: Opens signal path and grounds input to vertical amplifier. This provides a zero-signal base line, the position of which can be used as a reference when performing dc measurements. DC: Direct input of ac and dc component of channel 2 input signal.</p>	<p>_____</p>
<p>⑨ INPUT Jack Vertical input for channel 2 trace in normal sweep operation. External horizontal input in X-Y operation.</p>	<p>_____</p>
<p>⑩ CH2 INV In the NORM position (button released), the channel 2 signal is non-inverted. In the INV position (button engaged), the channel 2 signal is inverted.</p>	<p>_____</p>
<p>⑪ ◆ POSITION, X-Y ◀▶ Rotation adjusts vertical position of channel 2 trace. In X-Y operation adjusts horizontal position of display.</p>	<p>_____</p>

CS-1022, 1021, 1012

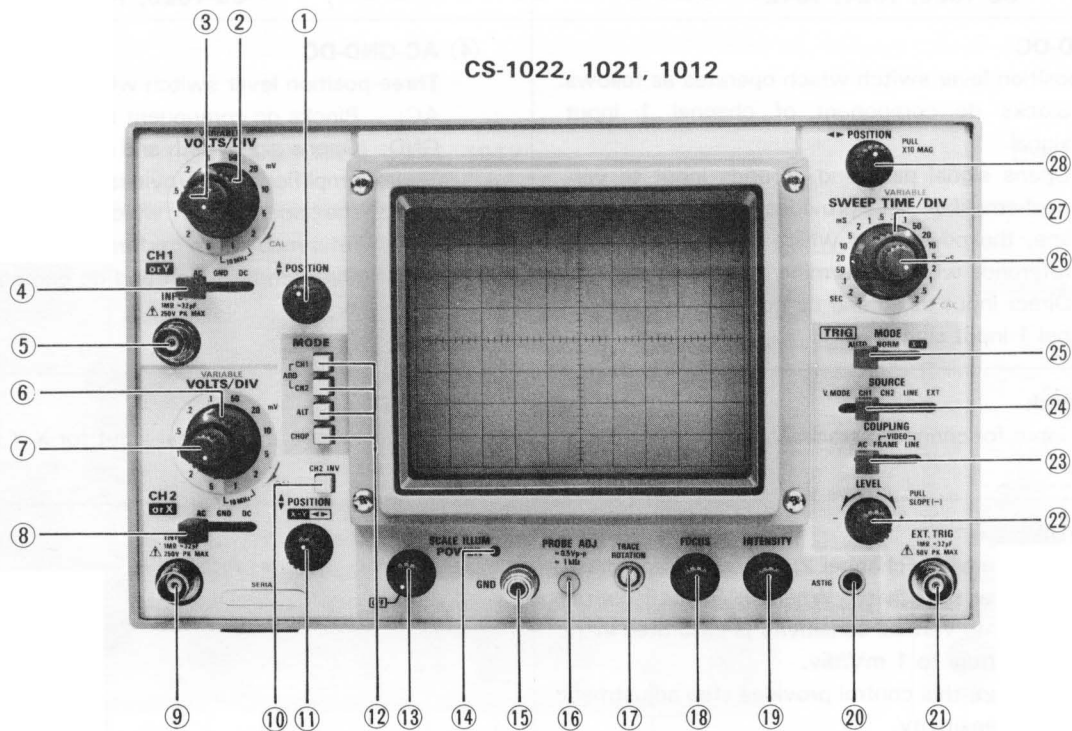


Fig. 4

CS-1022, 1021, 1012	CS-1020, 1010
<p>⑫ MODE Five-position push switch; selects the basic operating modes of the oscilloscope.</p> <p>CH1: Only the input signal to channel 1 is displayed as a single trace.</p> <p>CH2: Only the input signal to channel 2 is displayed as a single trace.</p> <p>ADD: When both CH1 and CH2 buttons are engaged, the waveforms from channel 1 and channel 2 inputs are added and the sum is displayed as a single trace. When the CH2 INV ⑩ button is engaged, the waveform from channel 2 is subtracted from the channel 1 waveform and the difference is displayed as a single trace.</p> <p>ALT: Alternate sweep is selected regardless of sweep time.</p> <p>CHOP: Chop sweep is selected regardless of sweep time at approximately 250 kHz.</p>	<p>⑫ MODE Five-position push switch; selects the basic operating modes of the oscilloscope.</p> <p>CH1: Only the input signal to channel 1 is displayed as a single trace.</p> <p>CH2: Only the input signal to channel 2 is displayed as a single trace.</p> <p>ADD: When both CH1 and CH2 buttons are engaged, the waveforms from channel 1 and channel 2 inputs are added and the sum is displayed as a single trace. When the CH2 INV ⑩ button is engaged, the waveform from channel 2 is subtracted from the channel 1 waveform and the difference is displayed as a single trace.</p> <p>ALT: Alternate sweep is selected regardless of sweep time.</p> <p>CHOP: Chop sweep is selected regardless of sweep time at approximately 250 kHz.</p>
<p>⑬ POWER, SCALE ILLUM (Except CS-1021) Fully counterclockwise rotation of this control (OFF position) turns off oscilloscope. Clockwise rotation turns on oscilloscope. Further clockwise rotation of the control increases the illumination level of the scale.</p>	<p>⑬ POWER, SCALE ILLUM Fully counterclockwise rotation of this control (OFF position) turns off oscilloscope. Clockwise rotation turns on oscilloscope. Further clockwise rotation of the control increases the illumination level of scale.</p>
<p>⑭ PILOT Lamp Lamp Lights when oscilloscope is turned on.</p>	<p>⑭ PILOT Lamp Lights when oscilloscope is turned on.</p>

CS-1022, 1021, 1012	CS-1020, 1010
<p>⑮ GND terminal/binding post. Earth and chassis ground.</p>	<p>⑮ GND terminal/binding post. Earth and chassis ground.</p>
<p>⑯ PROBE ADJ. Provides approximately 1 kHz, 0.5 Volt peak-to-peak square wave signal. This is useful for probe compensation adjustment.</p>	<p>⑯ PROBE ADJ. Provides approximately 1 kHz, 0.5 Volt peak-to-peak square wave signal. This is useful for probe compensation adjustment.</p>
<p>⑰ TRACE ROTATION Electrically rotates trace to horizontal position. Strong magnetic fields may cause the trace to be tilted. The degree of tilt may vary as the scope is moved from one location to another. In these cases, adjust this control.</p>	<p>⑰ TRACE ROTATION Electrically rotates trace to horizontal position. Strong magnetic fields may cause the trace to be tilted. The degree of tilt may vary as the scope is moved from one location to another. In these cases, adjust this control.</p>
<p>⑱ FOCUS Adjusts the trace for optimum focus.</p>	<p>⑱ FOCUS Adjusts the trace for optimum focus.</p>
<p>⑲ INTENSITY Clockwise rotation of this control increases the brightness of the trace.</p>	<p>⑲ INTENSITY Clockwise rotation of this control increases the brightness of the trace.</p>
<p>⑳ ASTIG Astigmatism adjustment provides optimum spot roundness when used in conjunction with FOCUS and INTENSITY controls. Very little readjustment of this control is required after initial adjustment.</p>	<p>⑳ ASTIG Astigmatism adjustment provides optimum spot roundness when used in conjunction with FOCUS and INTENSITY controls. Very little readjustment of this control is required after initial adjustment.</p>
<p>㉑ EXT TRIG INPUT Jack Input terminal for external trigger signal. When SOURCE switch is selected in EXT position, the input signal at the EXT TRIG INPUT jack becomes the trigger.</p>	<p>㉑ EXT TRIG INPUT Jack Input terminal for external trigger signal and external horizontal input terminal for X-Y operation. When SOURCE switch is selected in EXT position, the input signal at the EXT TRIG INPUT jack becomes the trigger.</p>
<p>㉒ LEVEL/PULL SLOPE (–) LEVEL: Trigger level adjustment determines point on waveform where sweep starts. When COUPLING switch is selected in VIDEO-FRAME or LINE, the trigger level adjustment has no effect. SLOPE: + equals most positive point of triggering and – equals most negative point of triggering. Push-pull switch selects positive or negative slope. Sweep is triggered on negative-going slope of sync waveform with switch pulled out.</p>	<p>㉒ LEVEL/ PULL SLOPE (–) LEVEL: Trigger level adjustment determines point on waveform where sweep starts. When COUPLING switch is selected in VIDEO-FRAME or LINE, the trigger level adjustment has no effect. SLOPE: + equals most positive point of triggering and – equals most negative point of triggering. Push-pull switch selects positive or negative slope. Sweep is triggered on negative-going slope of sync waveform with switch pulled out.</p>

CS-1022, 1021, 1012

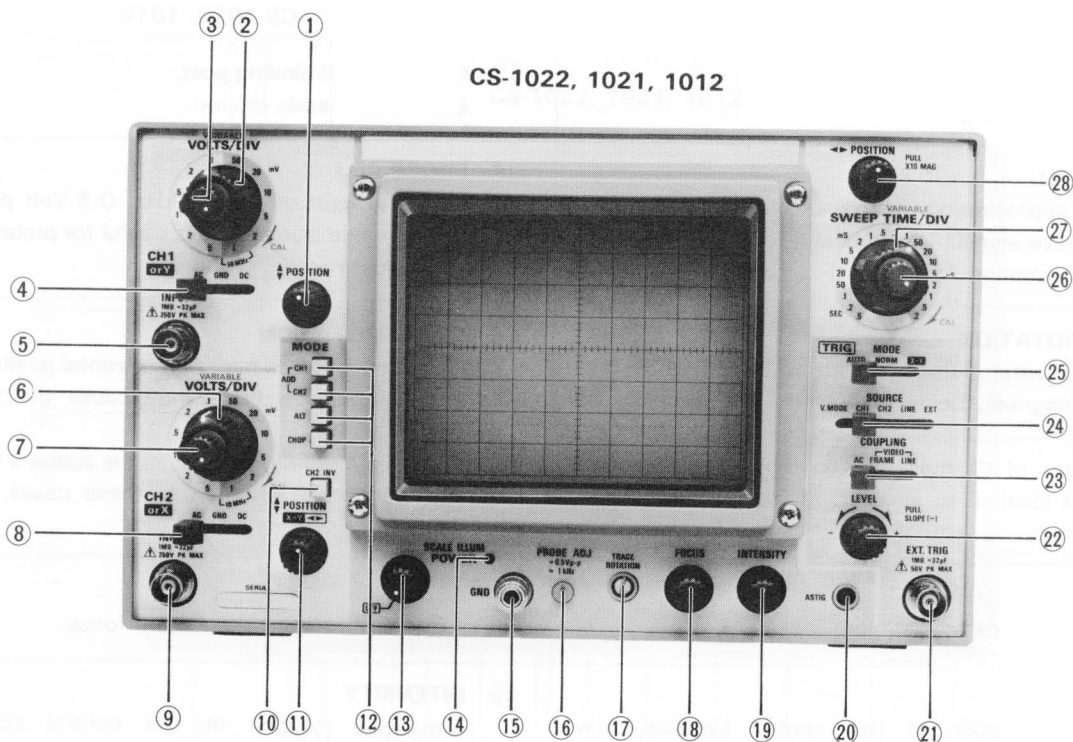


Fig. 5

CS-1022, 1021, 1012	CS-1020, 1010
<p>②③ COUPLING Three-position lever switch; selects coupling for sync trigger signal.</p> <p>AC: Trigger is ac coupled. Blocks dc component of input signal; most commonly used position.</p> <p>VIDEO FRAME: Vertical sync pulses of a composite video signal are selected for triggering.</p> <p>VIDEO LINE: Horizontal sync pulses of a composite video signal are selected for triggering. The LINE position is also used for all non-video waveforms.</p>	<p>②③ COUPLING Three-position lever switch; selects coupling for sync trigger signal.</p> <p>AC: Trigger is ac coupled. Blocks dc component of input signal; most commonly used position.</p> <p>VIDEO FRAME: Vertical sync pulses of a composite video signal are selected for triggering.</p> <p>VIDEO LINE: Horizontal sync pulses of a composite video signal are selected for triggering. The LINE position is also used for all non-video waveforms.</p>
<p>②④ SOURCE Five-position lever switch; selects triggering source for the sweep, with following positions; V. MODE: The trigger source is determined by vertical MODE selection.</p> <p>CH1: Channel 1 signal is used as a trigger source.</p> <p>CH2: Channel 2 signal is used as a trigger source.</p> <p>ADD: The algebraic sum of channel 1 and channel 2 signal is the trigger source. (If CH2 INV engaged, the difference becomes the trigger source.)</p>	<p>②④ SOURCE Three-position lever switch; selects triggering source for the sweep, with following positions;</p> <p>INT: Waveform being observed is used as sync trigger.</p> <p>LINE: Sweep is triggered by line voltage (50/60 Hz).</p> <p>EXT: Sweep is triggered by signal applied to EXT TRIG INPUT jack ②①.</p>

CS-1022, 1021, 1012	CS-1020, 1010
<p>CHOP: The display cannot be synchronized with the input signal since the chopping signal becomes the trigger source.</p> <p>CH1: Sweep is triggered by channel 1 signal regardless of vertical MODE selection.</p> <p>CH2: Sweep is triggered by channel 2 signal regardless of vertical MODE selection.</p> <p>LINE: Sweep is triggered by line voltage (50/60 Hz).</p> <p>EXT: Sweep is triggered by signal applied to EXT TRIG INPUT jack ⑳ .</p>	
<p>⑳ TRIG MODE Three-position lever switch; selects triggering mode.</p> <p>AUTO: Triggered sweep operation when trigger signal is present, automatically generates sweep (free runs) in absence of trigger signal.</p> <p>NORM: Normal triggered sweep operation. No trace is presented when a proper trigger signal is not applied.</p> <p>X-Y: X-Y operation. Channel 1 input signal produces vertical deflection (Y axis). Channel 2 input signal produces horizontal deflection (X axis). This operates regardless vertical MODE selection.</p>	<p>⑳ TRIG MODE Three-position lever switch; selects triggering mode.</p> <p>AUTO: Triggered sweep operation when trigger signal is present, automatically generates sweep (free runs) in absence of trigger signal.</p> <p>NORM: Normal triggered sweep operation. No trace is presented when a proper trigger signal is not applied.</p> <p>X-Y: X-Y operation. Vertical input signal produces vertical deflection (Y axis). EXT TRIG input produces horizontal deflection (X axis).</p>
<p>㉑ VARIABLE Control Fine sweep time adjustment. In the fully clockwise (CAL) position, the sweep time is calibrated.</p>	<p>㉑ VARIABLE Control Fine sweep time adjustment. In the fully clockwise (CAL) position, the sweep time is calibrated. For X-Y operation, this control serves as the X axis gain adjustment.</p>
<p>㉒ SWEEP TIME/DIV Horizontal coarse sweep time selector. Selects calibrated sweep times of 0.2 μs/div to 0.5 s/div in 20 steps (CS-1021, CS-1012... 0.5 μs/div to 0.5 s/div in 19 steps) when sweep time VARIABLE control ㉑ is set to CAL position (fully clockwise).</p>	<p>㉒ SWEEP TIME/DIV Horizontal coarse sweep time selector. Selects calibrated sweep times of 0.2 μs/div to 0.5 s/div in 20 steps (CS-1010... 0.5 μs/div to 0.5 s/div in 19 steps) when sweep time VARIABLE control ㉑ is set to CAL position (fully clockwise).</p>
<p>㉓ ◀▶ POSITION, PULL \times 10 MAG Rotation adjusts horizontal position of trace. Push-pull switch selects \times 10 magnification (PULL \times 10 MAG) when pulled out; normal when pushed in.</p>	<p>㉓ ◀▶ POSITION, PULL \times 10 MAG Rotation adjusts horizontal position of trace. Push-pull switch selects \times 10 magnification (PULL \times 10 MAG) when pulled out; normal when pushed in. For X-Y operation, this control serves as the X axis position control.</p>

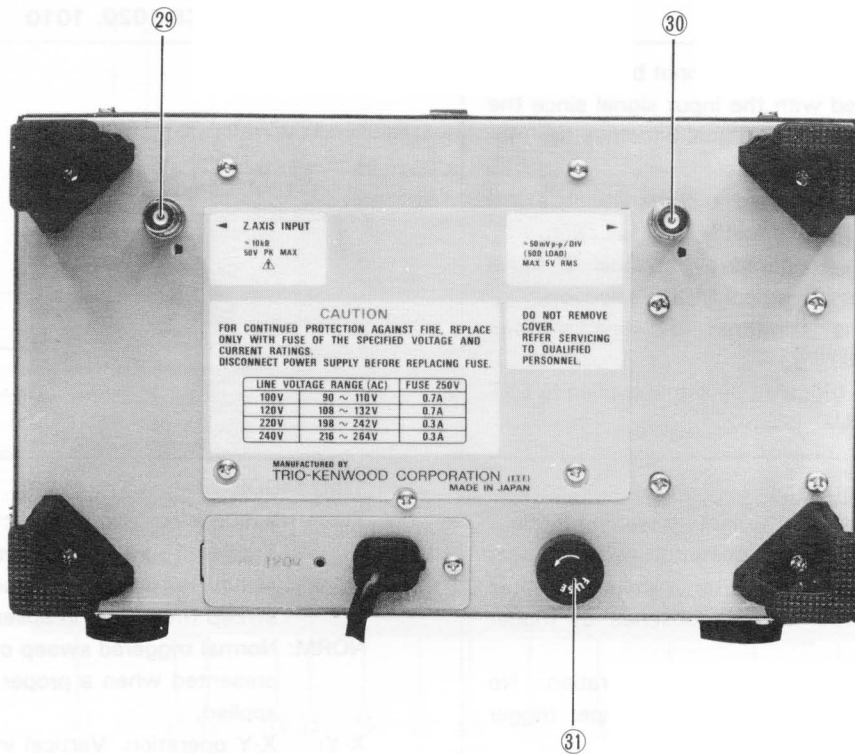


Fig. 6

REAR PANEL

CS-1022, 1021, 1012	CS-1020, 1010
<p>②9 Z AXIS INPUT External intensity modulation input; TTL compatible. Positive voltage increases brightness, negative voltage decreases brightness.</p>	<p>②9 Z AXIS INPUT External intensity modulation input; TTL compatible. Positive voltage increases brightness, negative voltage decreases brightness.</p>
<p>③0 CH1 OUTPUT (Except CS-1021) CH1 vertical output signal connector. AC coupled output connector. This connector is used to measure the frequency by connecting the frequency counter. For stable operation, do not connect CH1 OUTPUT to channel 2 input as cascaded operation.</p>	<p>③0 VERT OUTPUT Vertical output signal connector. AC coupled output connector. This connector is used to measure the frequency by connecting the frequency counter.</p>
<p>③1 Fuse Holder Contains the line fuse. Verify that the proper fuse is installed when replacing the line fuse. 100 V, 120 V0.8A 220 V, 240 V0.5A</p>	<p>③1 Fuse Holder Contains the line fuse. Verify that proper fuse is installed when replacing the line fuse. 100V, 120V0.8A 220V, 240V0.5A</p>

OPERATION

INITIAL STARTING PROCEDURE

Until you familiarize yourself with the use of all controls, the following procedure may be used to standardize the initial setting of controls as a reference point and to obtain

trace on the CRT in preparation for waveform observation. When using the probe(s), refer to probe's instructions and "PROBE COMPENSATION" listed in APPLICATION of this manual.

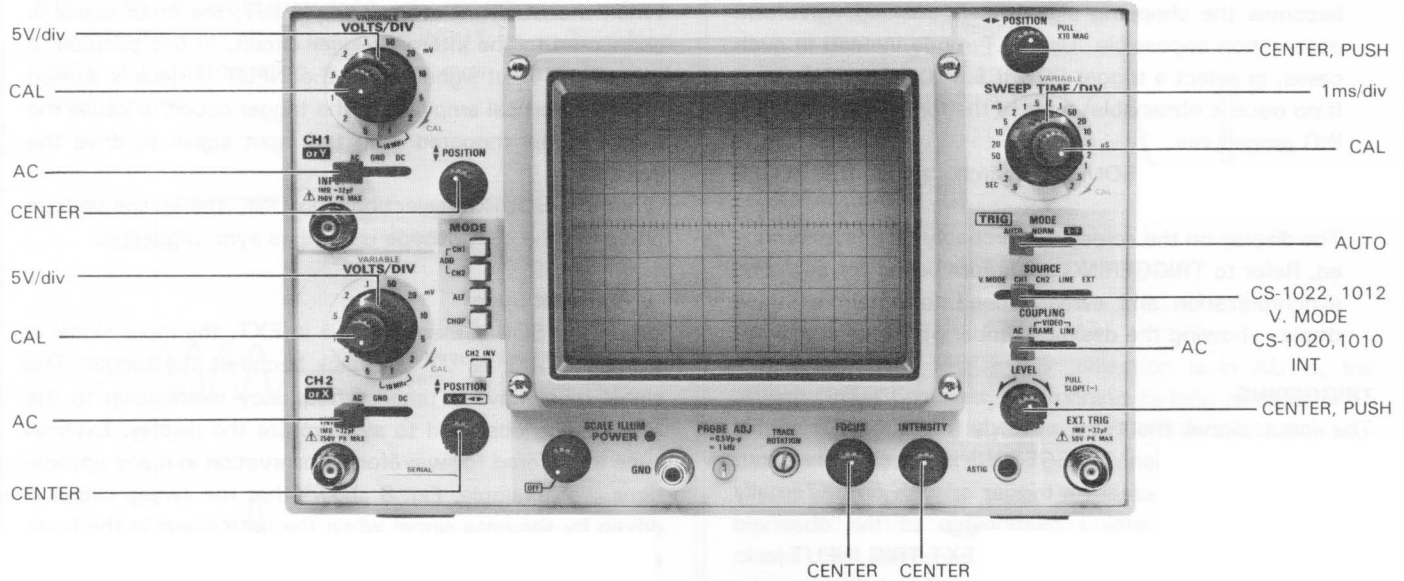


Fig. 7

CS-1022, 1021, 1012	CS-1020, 1010
<p>(1) NORMAL SWEEP DISPLAY OPERATION</p> <ol style="list-style-type: none"> Turn the POWER control ⑬ clockwise — the power supply will be turned on and the pilot lamp will light. Set these modes as follows: MODE ⑫ : CH1 TRIG MODE ⑳ : AUTO The trace will appear in the center of the CRT display and can be adjusted by the CH1 ▲ POSITION ① and ◀ POSITION ㉘ controls. Next, adjust the INTENSITY ⑲ and, if necessary, the FOCUS ⑱ for ease of observation. Vertical Modes With vertical MODE ⑫ set to CH1, apply an input signal to the CH1 INPUT ⑤ jack and adjust the VOLTS/DIV ② control for a suitable size display of the waveform. If the waveform does not appear in the display, adjust the VOLTS/DIV and ▲ POSITION controls to bring the waveform into the center portion of the CRT display. Operation with a signal applied to the CH2 INPUT ⑨ jack and the vertical MODE set to CH2 is similar to the above procedure. In the ADD mode, the algebraic sum of CH1 + CH2 is displayed. If the CH2 INV ⑩ switch has been engaged, the algebraic difference of the two waveforms, CH1 - CH2 is displayed. If both channels are set to the same VOLTS/DIV, the sum or difference can be read directly in VOLTS/DIV from the CRT. In the ALT mode, 	<p>(1) NORMAL SWEEP DISPLAY OPERATION</p> <ol style="list-style-type: none"> Turn the POWER control ⑬ clockwise—the power supply will be turned on and the pilot lamp will light. Set the TRIG MODE ㉕ to AUTO position. The trace will appear in the center of the CRT display and can be adjusted by the ▲ POSITION ① and ◀ POSITION ㉘ controls. Next, adjust the INTENSITY ⑲ and, if necessary, the FOCUS ⑱ for ease of observation. Apply an input signal to INPUT ⑤ jack and adjust the VOLTS/DIV ② control for a suitable size display of the waveform. If the waveform does not appear in the display, adjust the VOLTS/DIV and ▲ POSITION controls to bring the waveform into the center portion of the CRT display. If no trace is obtainable, refer to the following TRIGGERING procedures. The display on the screen will probably be unsynchronized. Refer to TRIGGERING procedures below adjusting synchronization and sweep speed to obtain a stable display showing the desired number of waveforms. <p>TRIGGERING</p> <p>The input signal must be properly triggered for stable waveform observation. TRIGGERING is possible the input signal INTernally to create a trigger or with an EXTernally</p>

one sweep displays the channel 1 signal and the next sweep displays the channel 2 signal in an alternating sequence.

In the CHOP mode, the sweep is chopped at an approximate 250 kHz rate and switched between CH1 and CH2. Note that in the CHOP mode of operation with the SOURCE switch set to V. MODE, the trigger source becomes the chopping signal itself, making waveform observation impossible. Use ALT mode instead in such cases, or select a trigger SOURCE of CH1 or CH2.

If no trace is obtainable, refer to the following TRIGGERING procedures.

4. After setting the SOURCE switch, adjust the SLOPE control.

The display on the screen will probably be unsynchronized. Refer to TRIGGERING procedure below for adjusting synchronization and sweep speed to obtain a stable display showing the desired number of waveform.

TRIGGERING

The input signal must be properly triggered for stable waveform observation. TRIGGERING is possible the input signal INTERNALLY to create a trigger or with an EXTERNALLY provided signal of timing relationship to the observed signal, applying such a signal to the EXT TRIG INPUT jack. The SOURCE switch selects the input signal that is to be used to trigger the sweep, with INT sync possibilities (V.MODE, CH1, CH2, LINE) and EXT sync possibility.

★ Internal Sync

When the SOURCE selection is in INT (V.MODE, CH1, CH2, LINE), the input signal is connected to the internal trigger circuit. In this position, a part of the input signal fed to the INPUT ⑤ or ⑨ jack is applied from the vertical amplifier to the trigger circuit to cause the trigger signal triggered with the input signal to drive the sweep.

When the V.MODE position is selected, the trigger source is dependent upon the vertical MODE selection.

When the vertical MODE selection is in ALT, the ALT position is very convenient for measuring the time duration of the waveform. However, for phase or timing comparisons between the channel 1 and channel 2 waveforms, both traces must be triggered by the same sync signal.

When the SOURCE selection is in CH1, the input signal at the channel 1 INPUT ⑤ jack becomes trigger regardless of the position of vertical MODE. When the SOURCE selection is in CH2, the input signal at the channel 2 INPUT ⑨ jack becomes trigger regardless of the position of vertical MODE. When the SOURCE selection in LINE, the ac line voltage powering the oscilloscope is used as sync triggering.

★ External Sync

When the SOURCE selection is in EXT, the input signal at the EXT TRIG INPUT ⑫ jack becomes the trigger. This signal must have a time or frequency relationship to the

provided signal of timing relationship to the observed signal, applying such a signal to the EXT TRIG INPUT jack. The SOURCE switch selects the input signal that is to be used to trigger the sweep, with INT sync possibility and EXT sync possibility.

★ Internal Sync

When the SOURCE selection is in INT, the input signal is connected to the internal trigger circuit. In this position, a part of the input signal fed to the INPUT ⑤ jack is applied from the vertical amplifier to the trigger circuit to cause the trigger signal triggered with the input signal to drive the sweep.

When the SOURCE selection is in LINE, the ac line voltage powering the oscilloscope is used as sync triggering.

★ External Sync

When the SOURCE selection is in EXT, the input signal at the EXT TRIG INPUT ⑫ jack becomes the trigger. This signal must have a time or frequency relationship to the signal being observed to synchronize the display. External sync is preferred for waveform observation in many applications. For example, Fig. 8 shows that the sweep circuit is driven by the gate signal when the gate signal in the burst signal is applied to the EXT TRIG INPUT jack. Fig. 8 also shows the input/output signals, where the burst signal generated from the gate signal is applied to the instrument under test. Thus, accurate triggering can be achieved without regard to the input signal fed to the INPUT ⑤ jack so that no further triggering is required even when the input signal is varied.

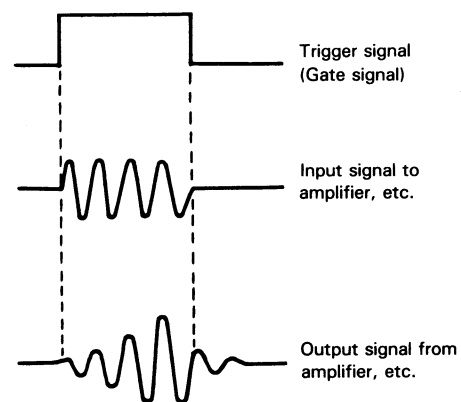


Fig. 8

signal being observed to synchronize the display. External sync is preferred for waveform observation in many applications. For example, Fig. 8 shows that the sweep circuit is driven by the gate signal when the gate signal in the burst signal is applied to the EXT TRIG INPUT jack. Fig. 8 also shows the input/output signals, where the burst signal generated from the signal is applied to the instrument under test. Thus, accurate triggering can be achieved without regard to the input signal fed to the INPUT ⑤ or ⑨ jack so that no further triggering is required even when the input signal is varied.

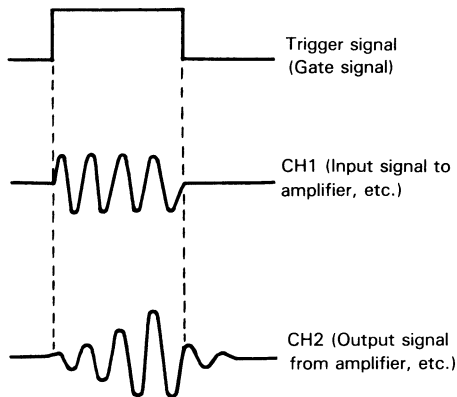


Fig. 8

★ Triggering Level

Trigger point on waveform is adjusted by the LEVEL/PULL SLOPE ② control. Fig. 9 shows the relationship between the SLOPE and LEVEL of the trigger point. Triggering level can be adjusted as necessary.

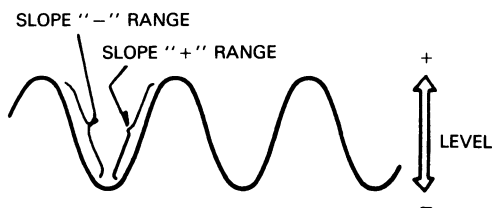


Fig. 9

★ Auto Trigger

When the TRIG MODE ② selection is in AUTO, the sweep circuit becomes free-running as long as there is no trigger signal, permitting a check of GND level. When a trigger signal is present, the trigger point can be determined by the LEVEL control for observation as in the normal trigger signal. When the trigger level exceeds the limit, the trigger circuit also becomes free-running where the waveform starts running. When the LEVEL control is pushed in and/or, when the trigger signal is absent or the triggering level exceeds the limit, there is no sweep.

★ Triggering Level

Trigger point on waveform is adjusted by the LEVEL/PULL SLOPE ② control. Fig. 9 shows the relationship between the SLOPE and LEVEL of the trigger point. Triggering level can be adjusted as necessary.

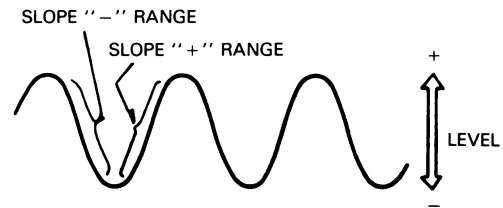


Fig. 9

★ Auto Trigger

When the TRIG MODE ② selection is in AUTO, the sweep circuit becomes free-running as long as there is no trigger signal, permitting a check of GND level. When a trigger signal is present, the trigger point can be determined by the LEVEL control for observation as in the normal trigger signal. When the trigger level exceeds the limit, the trigger circuit also becomes free-running where the waveform starts running. When the LEVEL control is pushed in and/or, when the trigger signal is absent or the triggering level exceeds the limit, there is no sweep.

(2) MAGNIFIED SWEEP OPERATION

Since merely shortening the sweep time to magnify a portion of an observed waveform can result in the desired portion disappearing off the screen, such magnified display should be performed using the MAGNIFIED SWEEP.

Using the ◀► POSITION control, adjust the desired portion of waveform to the CRT. Pull out the PULL × 10 MAG control to magnify the display 10 times. For this type of display the sweep time is the SWEEP TIME/DIV setting divided by 10.

(3) X-Y OPERATION

For some measurements, an external horizontal deflection signal is required. This is also referred to as an X-Y measurement, where the Y input provides vertical deflection and X input provides horizontal deflection.

X-Y operation permits the oscilloscope to perform many types of measurements not possible with conventional sweep operation. The CRT display becomes an electronic graph of two instantaneous voltages. The display may be a direct comparison of two voltages such as during phase measurement, frequency measurement with Lissajous waveforms.

To use an external horizontal input, use the following procedure;

1. Set the TRIG MODE switch to X-Y the position.
2. Use the channel 1 probe for the vertical input and the channel 2 probe for the horizontal input.
3. Adjust the amount of horizontal deflection with the CH2 VOLTS/DIV and VARIABLE controls.
4. The CH2 (vertical) POSITION ① control now serves as the horizontal position control, and the ◀► POSITION control is disabled.
5. All sync controls are disconnected and have no effect.

(4) VIDEO SIGNAL OBSERVATION

The VIDEO FRAME/LINE switch permits selection of vertical or horizontal sync pulse for sweep triggering when viewing composite video waveforms. In the LINE position, horizontal sync pulses are selected as triggers to permit viewing of horizontal line of video. This is also the position used for viewing all non-video waveforms. In the FRAME position, vertical sync pulses are selected as triggers to permit viewing of vertical fields and frames of video. When observing the video waveforms, stable display is obtained on the screen regardless the TRIG LEVEL ② control.

At most points of measurement, a composite video signal is of the polarity, that is, the sync pulses are negative and the video is positive. In this case, use "—" SLOPE.

If the waveform is taken at a circuit point where the video waveform is inverted, the sync pulses are positive and the video is negative. In this case, use "+" SLOPE.

(2) MAGNIFIED SWEEP OPERATION

Since merely shortening the sweep time to magnify a portion of an observed waveform can result in the desired portion disappearing off the screen, such magnified display should be performed using the MAGNIFIED SWEEP.

Using the ◀► POSITION control, adjust the desired portion of waveform to the CRT. Pull out the PULL × 10 MAG control to magnify the display 10 times. For this type of display the sweep time is the SWEEP TIME/DIV setting divided by 10.

(3) X-Y OPERATION

For some measurements, an external horizontal deflection signal is required. This is also referred to as an X-Y measurement, where Y input provides vertical deflection and the X input provided horizontal deflection. The horizontal input may be a sinusoidal wave, such as used for phase measurement, or an external sweep voltage. This input voltage must be about 100 millivolts per division of deflection (usually 1 volt or more peak-to-peak will provide satisfactory results). X and Y positions are adjusted using the ◀► POSITION ② and ◀► POSITION ① controls respectively. To use an external horizontal input, use the following procedure.

1. Set the TRIG MODE switch to the X-Y position.
2. Connect the external horizontal signal source through a cable to the EXT TRIG INPUT jack.
3. Adjust the amount of horizontal deflection with the VARIABLE control, which adjusts the gain to the horizontal amplifier.
4. All sync control are disconnected and have no effect.

(4) VIDEO SIGNAL OBSERVATION

The VIDEO FRAME/LINE switch permits selection of vertical or horizontal sync pulse for sweep triggering when viewing composite video waveforms. In the LINE position, horizontal sync pulses are selected as triggers to permit viewing of horizontal line of video. This is also the position used for viewing all non-video waveforms. In the FRAME position, vertical sync pulses are selected as triggers to permit viewing of vertical fields and frames of video. When observing the video waveforms, stable display is obtained on the screen regardless the TRIG LEVEL ② control.

At most points of measurement, a composite video signal is of the polarity, that is, the sync pulses are negative and the video is positive. In this case, use "—" SLOPE.

If the waveform is taken at a circuit point where the video waveform is inverted, the sync pulses are positive and the video is negative. In this case, use "+" SLOPE.

APPLICATION

PROBE COMPENSATION

If accurate measurements are to be made, the effect of the probe being used must be properly adjusted output of the measurement system using the internal calibration signal or some other squarewave source.

1. Connect probe to INPUT jack. Connect ground clip of probe of oscilloscope ground terminal and touch tip of probe to PROBE ADJ terminal.
2. Select single trace operation of channel 1, then channel 2, for step 3 and 4. (Unapplied to CS-1020 and CS-1010.)
Set the probe for 10:1 attenuation (10× position) and VOLTS/DIV to 10mV/div.
3. Set oscilloscope controls to display 3 or 4 cycles of PROBE ADJ square wave at 5 or 6 divisions amplitude.
4. Adjust compensation trimmer on probe for optimum square wave waveshape (minimum overshoot, rounding off, and tilt).

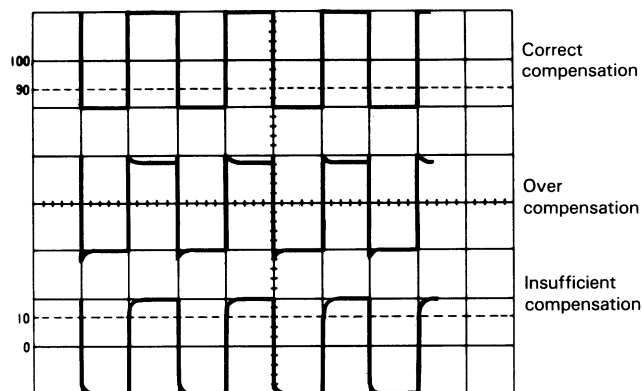


Fig. 10

TRACE ROTATION COMPENSATION

Rotation from a horizontal trace position can be the cause of measurement errors.

Adjust the controls for a single display. Set the AC-GND-DC switch to GND and TRIG MODE to AUTO. Adjust the POSITION control such that the trace is over the center horizontal graticule line. If the trace appears to be rotated from horizontal, align it with the center graticule line using the TRACE ROTATION control located on the front panel.

DC VOLTAGE MEASUREMENTS

This procedure describes the measurement procedure for DC waveforms.

Procedure:

1. Connect the signal to be measured to the INPUT jack. Set the vertical MODE to the channel to be used (unapplied to CS-1020 and 1010). Set the VOLTS/DIV and SWEEP TIME/DIV switch to obtain a normal display of the waveform to be measured. Set the VARIABLE control to the CAL position.

2. Set the TRIG MODE to AUTO and AC-GND-DC to the GND position, which established the zero volt reference. Using the POSITION control, adjust the trace position to the desired reference level position, making sure not to disturb this setting once made.
3. Set the AC-GND-DC switch to the DC position to observe the input waveform, including its DC component. If an appropriate reference level or VOLTS/DIV setting was not made, the waveform may not be visible on the CRT screen at this point. If so, reset VOLTS/DIV and/or the POSITION control.
4. Use the POSITION control to bring the portion of the waveform to be measured to the center vertical graduation line of the CRT screen.
5. Measure the vertical distance from the reference level to the point to be measured, (the reference level can be rechecked by setting the AC-GND-DC switch again to GND).

Multiply the distance measured above by the VOLTS/DIV setting and the probe attenuation ratio as well. Voltages above and below the reference level are positive and negative values respectively.

Using the formula:

DC level = Vertical distance in divisions × (VOLTS/DIV setting) × (probe attenuation ratio).

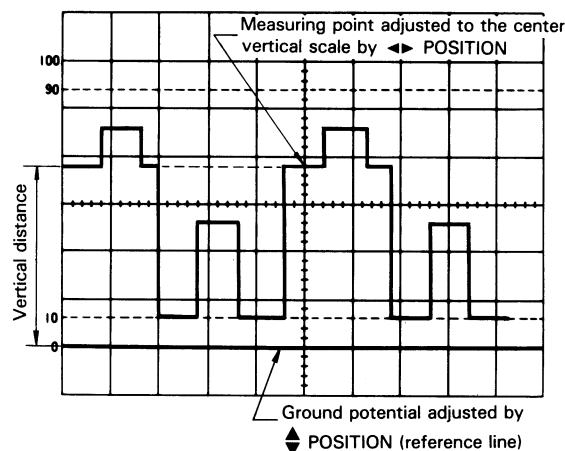


Fig. 11

[EXAMPLE]

For the example, the point being measured is 3.8 divisions from the reference level (ground potential).

If the VOLTS/DIV was set to 0.2 V and a 10:1 probe was used. (See Fig. 11)

Substituting the given values:

$$\text{DC level} = 3.8 \text{ (div)} \times 0.2 \text{ (V)} \times 10 = 7.6 \text{ V}$$

MEASUREMENT OF THE VOLTAGE BETWEEN TWO POINTS ON A WAVEFORM

This technique can be used to measure peak-to-peak voltages.

Procedure:

1. Apply the signal to be measured to the INPUT jack. Set the vertical MODE to the channel to be used (unapplied to CS-1020 and 1010). Set the AC-GND-DC to AC, adjusting VOLTS/DIV and SWEEP TIME/DIV for a normal display. Set the VARIABLE to CAL.
2. Using the \blacktriangleup POSITION control, adjust the waveform position such that one of the two points falls on a CRT graduation line and that the other is visible on the display screen.
3. Using the \blacktriangleleft POSITION control, adjust the second point to coincide with the center vertical graduation line.
4. Measure the vertical distance between the two points and multiply this by the setting of the VOLTS/DIV control.

If a probe is used, further multiply this by the attenuation ratio.

Using the formula:

$$\begin{aligned} \text{Volts Peak-to-Peak} \\ &= \text{Vertical distance (div)} \times (\text{VOLTS/DIV setting}) \times (\text{probe} \\ &\text{attenuation ratio}) \end{aligned}$$

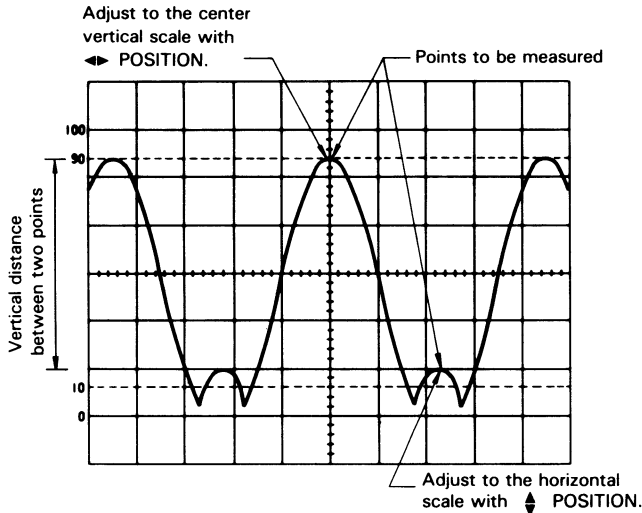


Fig. 12

[EXAMPLE]

For the example, the two points are separated by 4.4 divisions vertically. Set the VOLTS/DIV setting be 0.2 V/div and the probe attenuation be 10:1. (See Fig. 12)

Substituting the given value:

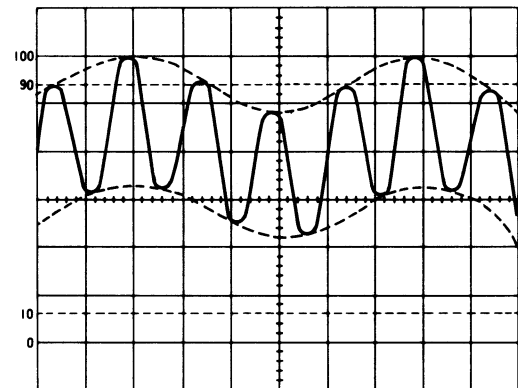
$$\text{Voltage between two points} = 4.4 (\text{div}) \times 0.2(\text{V}) \times 10 = 8.8\text{V}$$

ELIMINATION OF UNDESIRABLE SIGNAL COMPONENTS (Unapplied to CS-1020 and 1010)

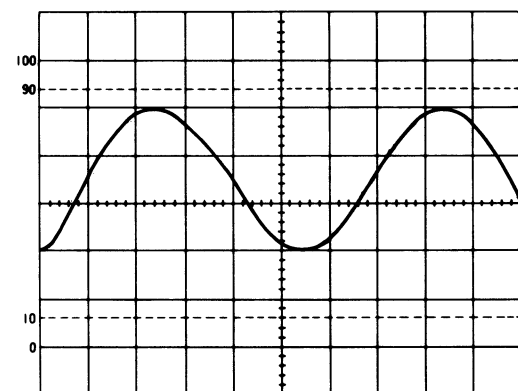
The ADD feature can be conveniently used to cancel out the effect of an undesired signal component which superimposed on the signal you wish to observe.

Procedure:

1. Apply the signal containing an undesired component to the CH1 INPUT jack and the undesired signal itself alone to the CH2 INPUT jack.
2. Set the vertical MODE to CHOP and SOURCE to CH2. Verify that CH2 represents the unwanted signal in reverse polarity. If necessary reverse polarity by setting CH2 to INV.
3. Set the vertical MODE to ADD, SOURCE to V. MODE and CH2 VOLTS/DIV and VARIABLE so that the undesired signal component is cancelled as much as possible. The remaining signal should be the signal you wish to observe alone and free of the unwanted signal.



Signal containing undesired component
(Broken lines: undesired component envelope)



Undesired component signal

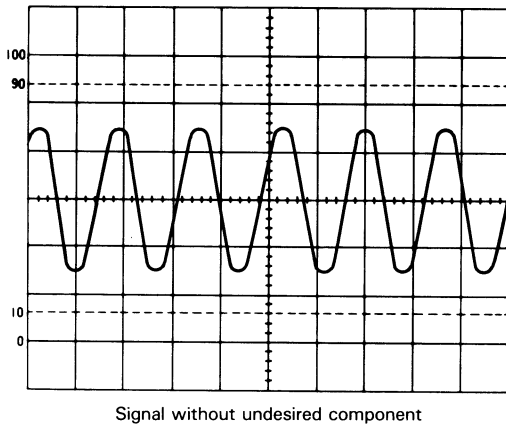


Fig. 13

TIME MEASUREMENTS

This is the procedure for making time measurements between two points on a waveform. The combination of the SWEEP TIME/DIV and the horizontal distance in divisions between the two points is used in the calculation.

Procedure:

1. Apply the signal to be measured to the INPUT jack. Set the vertical MODE to the channel to be used (unapplied to CS-1020 and 1010). Adjust the VOLTS/DIV and SWEEP TIME/DIV for a normal display. Be sure that the VARIABLE control is set to CAL.
2. Using the \blacktriangledown POSITION control, set one of the points to be used as a reference to coincide with the horizontal centerline. Use the \blacktriangleleft \blacktriangleright POSITION control to set this point at the intersection of any vertical graduation line.
3. Measure the horizontal distance between the two points.

Multiply this by the setting of the SWEEP TIME/DIV control to obtain the time between the two points. If horizontal "x 10 MAG" is used, multiply this further by 1/10.

Using the formula:

Time = Horizontal distance (div) x (SWEEP TIME/DIV setting) x "x 10 MAG" value⁻¹ (1/10)

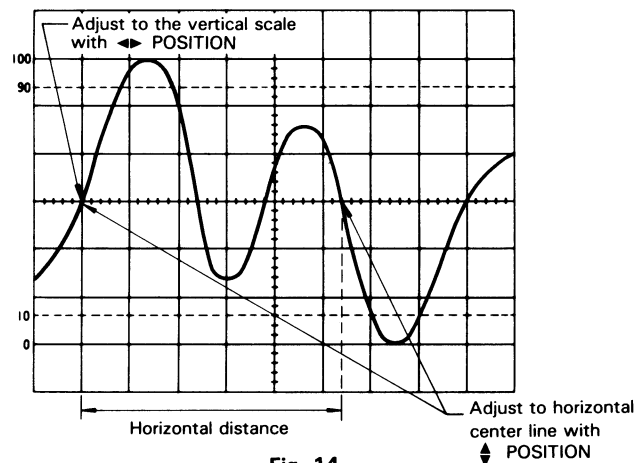


Fig. 14

[EXAMPLE]

For the example, the horizontal distance between the two points is 5.4 divisions.

If the SWEEP TIME/DIV is 0.2 ms/div we calculate. (See Fig. 14)

Substituting the given value:

$$\text{Time} = 5.4 (\text{div}) \times 0.2 (\text{ms}) = 1.08 \text{ ms}$$

FREQUENCY MEASUREMENTS

Frequency measurements are made by measuring the period of one cycle of waveform and taking the reciprocal of this time value as the frequency.

Procedure:

1. Set the oscilloscope up to display one cycle of waveform (one period).
2. The frequency is the reciprocal of the period measured.

Using the formula:

$$\text{Freq} = \frac{1}{\text{period}}$$

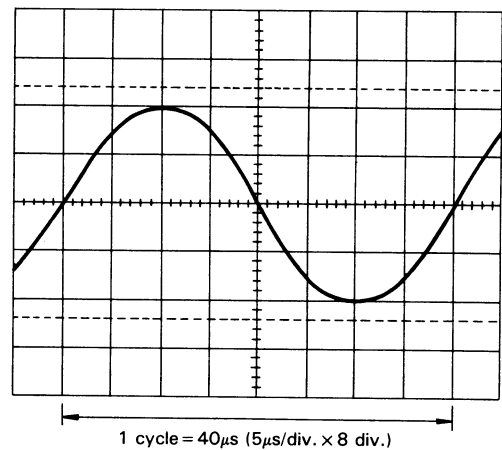


Fig. 15

[EXAMPLE]

A period of 40 μs is observed and measured. (See Fig. 15)

Substituting the given value:

$$\text{Freq} = 1/[40 \times 10^{-6}] = 2.5 \times 10^4 = 25 \text{ kHz}$$

While the above method relies on the measurement directly of the period of one cycle, the frequency may also be measured by counting the number of cycles present in a given time period.

1. Apply the signal to the INPUT jack. Set the vertical MODE to the channel to be used (unapplied to CS-1020 and 1010) and adjusting the various controls for a normal display. Set the VARIABLE to CAL.
2. Count the number of cycles of waveform between a chosen set of vertical graduation lines.

Using the horizontal distance between the vertical lines used above and the SWEEP TIME/DIV, the time span may be calculated. Multiply the reciprocal of this value

by the number of cycles present in the given time span.
 If "× 10 MAG" is used multiply this further by 10.
 Note that errors will occur for displays having only a few cycles.

Using the formula:

$$\text{Freq} = \frac{\text{\# of cycles} \times \text{"} \times 10 \text{ MAG" value}}{\text{Horizontal distance (div)} \times \text{SWEEP TIME/DIV setting}}$$

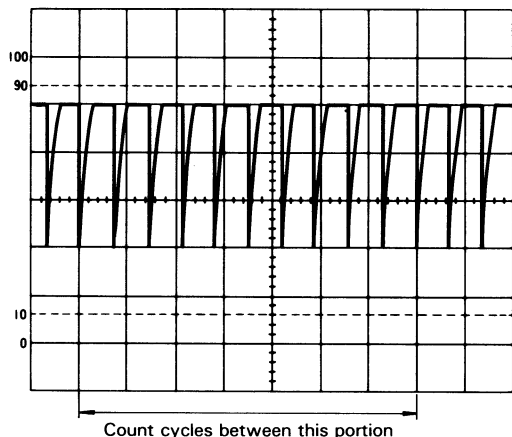


Fig. 16

[EXAMPLE]

For the example, within 7 divisions there are 10 cycles.
 The SWEEP TIME/DIV is 5 μs. (See Fig. 16)

Substituting the given value:

$$\text{Freq} = \frac{10}{7 \text{ (div)} \times 5 \text{ (}\mu\text{s)}} \cong 285.7 \text{ kHz}$$

PULSE WIDTH MEASUREMENTS

Procedure:

1. Apply the pulse signal to the INPUT jack. Set the vertical MODE to the channel to be used (unapplied to CS-1020 and 1010).
2. Use the VOLTS/DIV, VARIABLE and \blacktriangle POSITION to adjust the waveform such that the pulse is easily observed and such that the center pulse width coincides with the center horizontal line on the CRT screen.
3. Measure the distance between the intersection of the pulse waveform and the center horizontal line in divisions. Be sure that the VARIABLE is in the CAL. Multiply this distance by the SWEEP TIME/DIV and by 1/10 if "× 10 MAG" mode is being used.

Using the formula:

$$\text{Pulse width} = \text{Horizontal distance (div)} \times (\text{SWEEP TIME/DIV setting}) \times \text{"} \times \text{MAG" value}^{-1} (1/10)$$

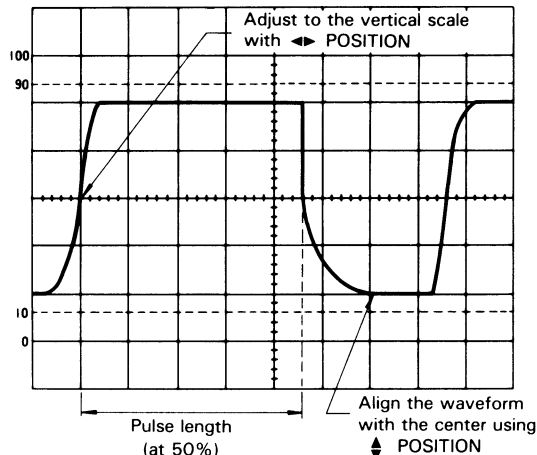


Fig. 17

[EXAMPLE]

For the example, the distance (width) at the center horizontal line is 4.6 divisions and the SWEEP TIME/DIV is 0.2 ms. (See Fig. 17)

Substituting the given value:

$$\text{Pulse width} = 4.6 \text{ (div)} \times 0.2 \text{ ms} = 0.92 \text{ ms}$$

PULSE RISETIME AND FALLTIME MEASUREMENTS

For risetime and falltime measurements, the 10% and 90% amplitude points are used as starting and ending reference points.

Procedure:

1. Apply a signal to the INPUT jack. Set the vertical MODE to the channel to be used (unapplied to CS-1020 and 1010).
 Use the VOLTS/DIV and VARIABLE to adjust the waveform peak-to-peak height to six divisions.
2. Using the \blacktriangledown POSITION control and the other controls, adjust the display such that the waveform is centered vertically in the display. Set the SWEEP TIME/DIV to as fast a setting as possible consistent with observation of both the 10% and 90% points. Set the VARIABLE to CAL.
2. Use the \blacktriangleleft POSITION control to adjust the 10% point to coincide with a vertical graduation line and measure the distance in divisions between the 10% and 90% points on the waveform. Multiply this by the SWEEP TIME/DIV and also by 1/10, if "× 10 MAG" mode was used.

NOTE:

Be sure that the correct 10% and 90% lines are used. For such measurements the 0, 10, 90 and 100% points are marked on the CRT screen.

Using the formula:

$$\text{Risetime} = \text{Horizontal distance (div)} \times (\text{SWEEP TIME/DIV setting}) \times \text{"} \times 10 \text{ MAG" value}^{-1} (1/10)$$

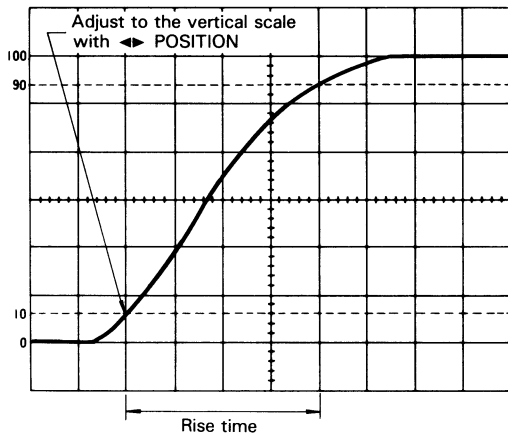


Fig. 18

[EXAMPLE]

For the example, the horizontal distance is 4.0 divisions. The SWEEP TIME/DIV is 2 μ s. (See Fig. 18)

Substituting the given value:
 $Risetime = 4.0 \text{ (div)} \times 2 \text{ (}\mu\text{s)} = 8\mu\text{s}$

Risetime and falltime can be measured by making use of the alternate step 3 as described below as well.

- Use the \blacktriangleleft POSITION control to set the 10% point to coincide with the center vertical graduation line and measure the horizontal distance to the point of the intersection of the waveform with the center horizontal line. Let this distance be D_1 . Next adjust the waveform position such that the 90% point coincides with the vertical centerline and measure the distance from that line to the intersection of the waveform with the horizontal centerline. This distance is D_2 and the total horizontal distance is then D_1 plus D_2 for use in the above relationship in calculating the rise time or falltime.

Using the formula:

$$Risetime = (D_1 + D_2) \text{ (div)} \times (\text{SWEEP TIME/DIV setting}) \times \text{''} \times 10 \text{ MAG'' value}^{-1} (1/10)$$

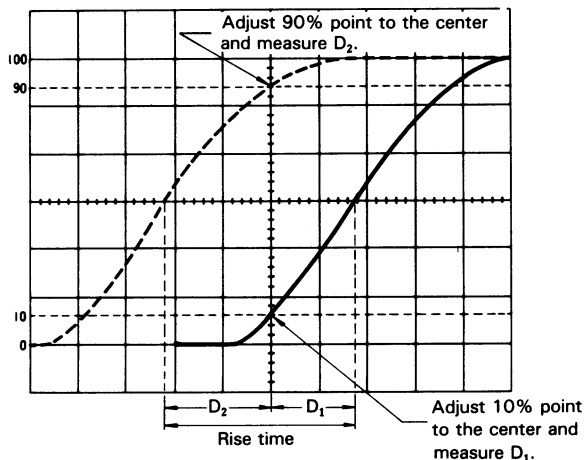


Fig. 19

[EXAMPLE]

For the example, the measured D_1 is 1.8 divisions while D_2 is 2.2 divisions. If SWEEP TIME/DIV is 2 μ s we use the following relationship. (See Fig. 19)

Substituting the given value:
 $Risetime = (1.8 + 2.2) \text{ (div)} \times 2 \text{ (}\mu\text{s)} = 8\mu\text{s}$

TIME DIFFERENCE MEASUREMENTS (Unapplied to CS-1020 and 1010)

This procedure is useful in measurement of time differences between two signals that are synchronized to one another but skewed in time.

Procedure:

- Apply the two signals to CH1 and CH2 INPUT jacks. Set the vertical MODE to either ALT or CHOP mode. Generally for low frequency signals CHOP is chosen with ALT used for high frequency signals.
- Select the faster of the two signals as the SOURCE and use the VOLTS/DIV and SWEEP TIME/DIV to obtain an easily observed display. Set the VARIABLE to CAL.
- Using the \blacklozenge POSITION control set the waveforms to the center of the CRT display and use the \blacktriangleleft POSITION control to set the reference signal to be coincident with a vertical graduation line.
- Measure the horizontal distance between the two signals and multiply this distance in divisions by the SWEEP TIME/DIV setting. If "x10 MAG" is being used multiply this again by 1/10.

Using the formula:

$$\text{Time} = \text{Horizontal distance (div)} \times (\text{SWEEP TIME/DIV setting}) \times \text{''} \times 10 \text{ MAG'' value}^{-1} (1/10)$$

[EXAMPLE]

For the example, the horizontal distance measured is 4.4 divisions. The SWEEP TIME/DIV is 0.2 ms. (See Fig. 20)

Substituting the given value:
 $\text{Time} = 4.4 \text{ (div)} \times 0.2 \text{ (ms)} = 0.88 \text{ ms}$

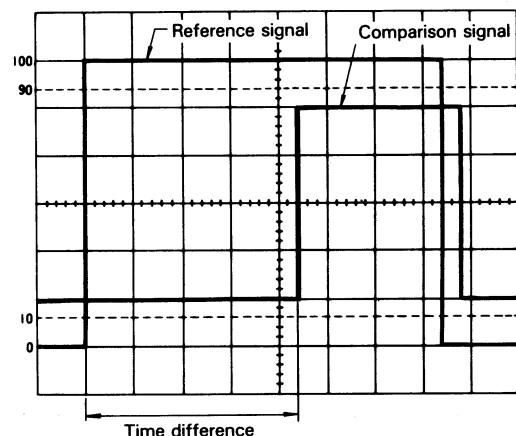


Fig. 20

PHASE DIFFERENCE MEASUREMENTS (Unapplied to CS-1020 and 1010)

This procedure is useful in measuring the phase difference of signals of the same frequency.

Procedure:

1. Apply the two signals to the CH1 and CH2 INPUT jacks, setting the vertical MODE to either CHOP or ALT mode.
2. Set the SOURCE to the signal which is leading in phase and use the VOLTS/DIV to adjust the signals such that they are equal in amplitude. Adjust the other controls for a normal display.
3. Use the SWEEP TIME/DIV and VARIABLE to adjust the display such that one cycle of the signals occupies 8 divisions of horizontal display.
Use the \blacktriangledown POSITION to bring the signals in the center of the screen.
Having set up the display as above, one division now represents 45° in phase.
4. Measure the horizontal distance between corresponding points on the two waveforms.

Using the formula:

$$\text{Phase difference} = \text{Horizontal distance (div)} \times 45^\circ/\text{div}$$

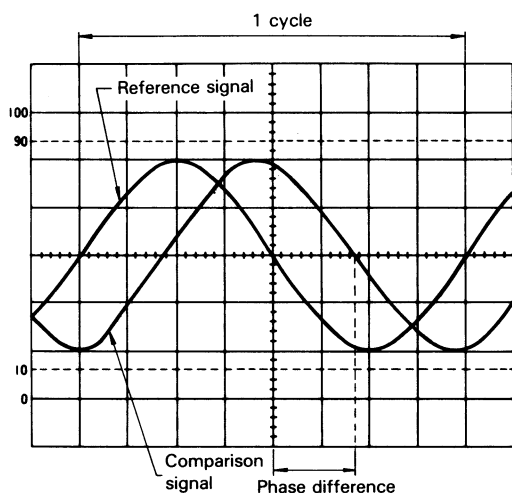


Fig. 21

[EXAMPLE]

For the example, the horizontal distance is 1.7 divisions.
(See Fig. 21)

Substituting the given value:

$$\text{The phase difference} = 1.7 (\text{div}) \times 45^\circ/\text{div} = 76.5^\circ$$

The above setup allows 45° per division but if more accuracy is required the SWEEP TIME/DIV may be changed and magnified without touching the VARIABLE control and if necessary the trigger level can be readjusted.

For this type of operation, the relationship of one division to 45° no longer holds. Phase difference is defined by the formula as follows.

$$\text{Phase difference} = \text{Horizontal distance of new sweep range (div)} \times 45^\circ/\text{div}$$

$$\times \frac{\text{New SWEEP TIME/DIV setting}}{\text{Original SWEEP TIME/DIV setting}}$$

Another simple method of obtaining more accuracy quickly is to simply use $\times 10$ MAG for a scale of $4.5^\circ/\text{div}$.

RELATIVE MEASUREMENT

If the frequency and amplitude of some reference signal are known, an unknown signal may be measured for level and frequency without use of the VOLTS/DIV or SWEEP TIME/DIV for calibration.

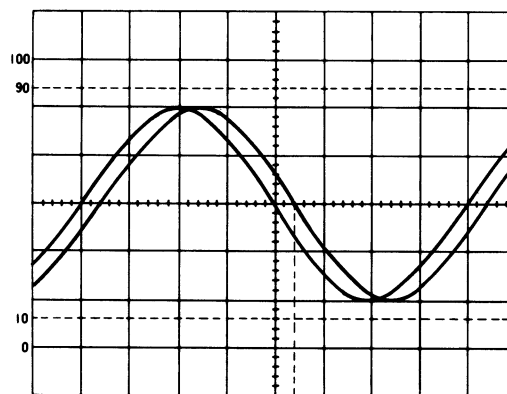
The measurement is made in units relative to the reference signal.

★ Vertical Sensitivity

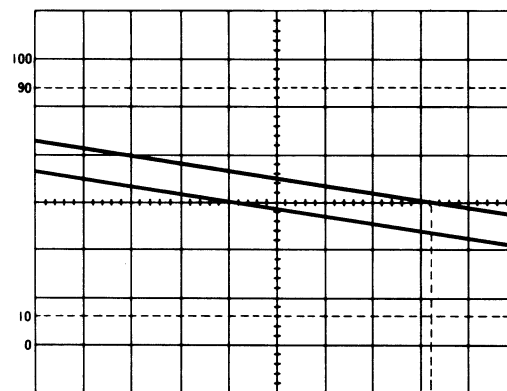
Setting the relative vertical sensitivity using a reference signal.

Procedure:

1. Apply the reference signal to the INPUT jack and adjust the display for a normal waveform display.
Adjust the VOLTS/DIV and VARIABLE so that the signal coincides with the CRT face's graduation lines. After adjusting, be sure not to disturb the setting of the VARIABLE control.



Phase difference
One cycle adjusted to occupy 8 div.



Phase difference
Expanded sweep waveform display.

Fig. 22

- The vertical calibration coefficient is now the reference signal's amplitude (in volts) divided by the product of the vertical amplitude set in step 1 and the VOLTS/DIV setting.

Using the formula:

Vertical coefficient

$$= \frac{\text{Voltage of the reference signal (V)}}{\text{Vertical amplitude (div)} \times \text{VOLTS/DIV setting}}$$

- Remove the reference signal and apply the unknown signal to the INPUT jack, using the VOLTS/DIV control to adjust the display for easy observation. Measure the amplitude of the displayed waveform and use the following relationship to calculate the actual amplitude of the unknown waveform.

Using the formula:

Amplitude of the unknown signal (V)

$$= \text{Vertical distance (div)} \times \text{Vertical coefficient} \times \text{VOLTS/DIV setting}$$

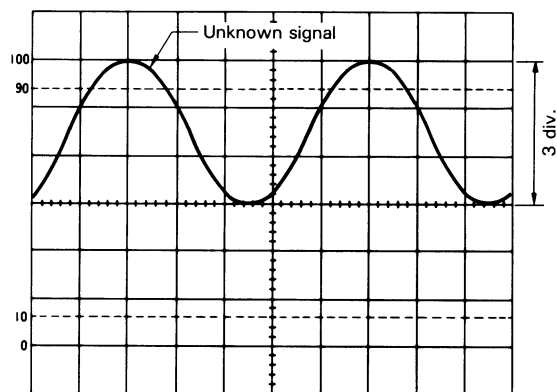
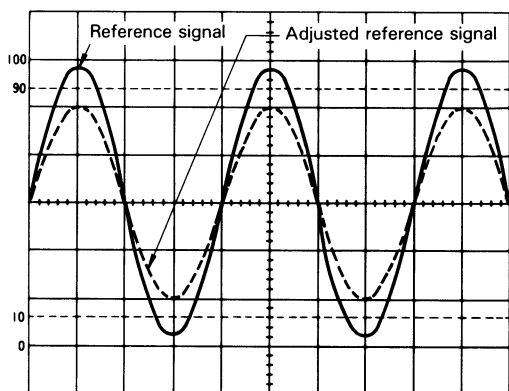


Fig. 23

[EXAMPE]

For the example, the VOLTS/DIV is 1 V.

The reference signal is 2 Vrms. Using the VARIABLE, adjust so that the amplitude of the reference signal is 4 divisions. (See Fig. 23)

Substituting the given value:

$$\text{Vertical coefficient} = \frac{2 \text{ Vrms}}{4 \text{ (div)} \times 1 \text{ (V)}} = 0.5$$

Then measure the unknown signal and VOLTS/DIV is 5 V and vertical amplitude is 3 divisions.

Substituting the given value:

$$\begin{aligned} \text{Effective value of unknown signal} &= 3 \text{ (div)} \times 0.5 \times 5 \text{ (V)} \\ &= 7.5 \text{ V rms} \end{aligned}$$

★ Period

Setting the relative sweep coefficient with respect to a reference frequency signal.

Procedure:

- Apply the reference signal to the INPUT jack, using the VOLTS/DIV and VARIABLE to obtain an easily observed waveform display. Using the SWEEP TIME/DIV and VARIABLE adjust one cycle of the reference signal to occupy a fixed number of scale divisions accurately. After this is done be sure not to disturb the setting of the VARIABLE control
- The Sweep (horizontal) calibration coefficient is then the period of the reference signal divided by the product of the number of divisions used in step 1 for setup of the reference and the setting of the SWEEP TIME/DIV control.

Using the formula:

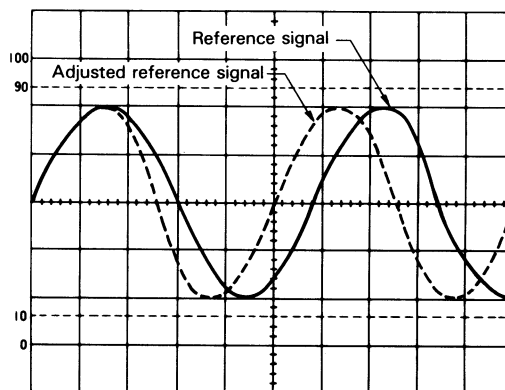
Sweep coefficient

$$= \frac{\text{Period of the reference signal (sec)}}{\text{horizontal width (div)} \times \text{SWEEP TIME/DIV setting}}$$

- Remove the reference signal and input the unknown signal, adjusting the SWEEP TIME/DIV control for easy observation. Measure the width of one cycle in divisions and use the following relationship to calculate the actual period.

Using the formula:

$$\text{Period of unknown signal} = \text{Width of 1 cycle (div)} \times \text{sweep coefficient} \times \text{SWEEP TIME/DIV setting}$$



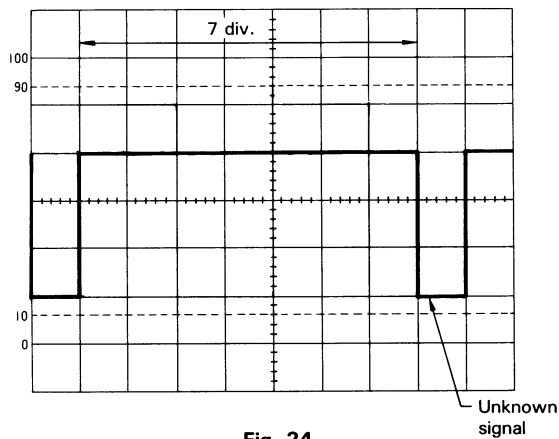


Fig. 24

[EXAMPLE]

SWEEP TIME/DIV is 0.1 ms and apply 1.75 kHz reference signal. Adjust the VARIABLE so that the distance of one cycle is 5 divisions.

Substituting the given value:

$$\text{Horizontal coefficient} = \frac{1.75 \text{ (kHz)}^{-1}}{5 \times 0.1 \text{ (ms)}} = 1.142$$

Then, SWEEP TIME/DIV is 0.2 ms and horizontal amplitude is 7 divisions. (See Fig. 24)

Substituting the given value:

$$\text{Pulse width} = 7 \text{ (div)} \times 1.142 \times 0.2 \text{ (ms)} \cong 1.6 \text{ ms}$$

APPLICATION OF X-Y OPERATION

CS-1022, 1021, 1012

★ Phase Shift Measurement

A method of phase measurement requires calculations based on the Lissajous patterns obtained using X-Y operations. Distortion due to non-linear amplification also can be displayed.

A sine wave input is applied to the audio circuit being tested. The same sine wave input is applied to the vertical input of the oscilloscope, and the output of the tested circuit is applied to the horizontal input of the oscilloscope. The amount of phase difference between the two signals can be calculated from the resulting waveform.

To make phase measurements, use the following procedure.

1. Using an audio signal generator with a pure sinusoidal signal, apply a sine wave test signal at the desired test frequency to the audio network being tested.
2. Set the signal generator output for the normal operating level of the circuit being tested. If desired, the circuit's output may be observed on the oscilloscope. If the test circuit is overdriven, the sine wave display on the oscilloscope is clipped and the signal level must be reduced.
3. Connect the channel 2 probe to the output of the test circuit.
4. Select X-Y operation by placing the TRIG MODE switch in the X-Y position.
5. Connect the channel 1 probe to the input of the test circuit.
(The input and output test connections to the vertical and horizontal oscilloscope inputs may be reserved.)
6. Adjust the channel 1 and 2 gain controls for a suitable viewing size.
7. Some typical results are shown in Fig. 26.
If the two signals are in phase, the oscilloscope trace is a straight diagonal line. If the vertical and horizontal gain are properly adjusted, this line is at a 45° angle. A 90° phase shift produces a circular oscilloscope pattern. Phase shift of less (or more) than 90° produces an elliptical oscilloscope pattern. The amount of phase shift can be calculated from the oscilloscope trace as shown in Fig. 25.

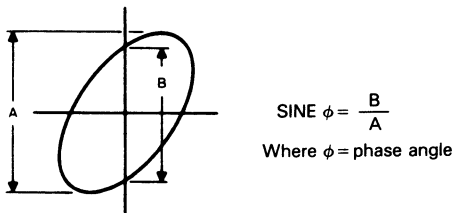


Fig. 25 Phase shift calculation

CS-1020, 1010

★ Phase Shift Measurement

Phase measurements may be made with an oscilloscope. Typical applications are circuits designed to produce a specific phase shift, and measurement of phase shift distortion in audio amplifiers or other audio networks. Distortion due to non-linear amplification is also displayed in the oscilloscope waveform.

A sine wave input is applied to the audio circuit being tested. The same sine wave input is applied to the vertical input of the oscilloscope, and the output of the tested circuit is applied to the horizontal input of the oscilloscope.

The amount of phase difference between the two signals can be calculated from the resulting waveform.

To make phase measurements, use the following procedure.

1. Using an audio signal generator with a pure sinusoidal signal, apply a sine wave test signal at the desired test frequency to the audio network being tested.
2. Set the signal generator output for the normal operating level of the circuit being tested. If desired, the circuit's output may be observed on the oscilloscope. If the test circuit is overdriven, the sine wave display on the oscilloscope is clipped and the signal level must be reduced.
3. Connect an external horizontal input cable from the output of the test circuit to the EXT TRIG INPUT jack of the oscilloscope.
4. Set the TRIG MODE switch to X-Y position for X-Y operation.
5. Connect the VERT. INPUT probe to the input of the test circuit. (The input and output test connections to the vertical and horizontal oscilloscope inputs may be reversed. Use the higher vertical gain of the oscilloscope for the lower level signal.)
6. Adjust the vertical and horizontal gain controls for a suitable viewing size.
7. Some typical results are shown in Fig. 26.
If the two signals are in phase, the oscilloscope trace is a straight diagonal line. If the vertical and horizontal gain are properly adjusted, this line is at a 45° angle. A 90° phase shift produces a circular oscilloscope pattern. Phase shift of less (or more) than 90° produces an elliptical oscilloscope pattern. The amount of phase shift can be calculated from the oscilloscope trace as shown in Fig. 25.

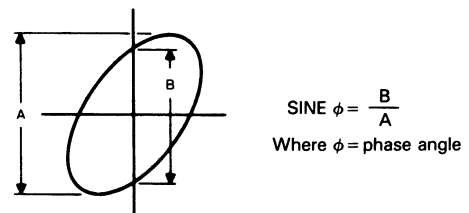


Fig. 25 Phase shift calculation

CS-1022, 1021, 1012

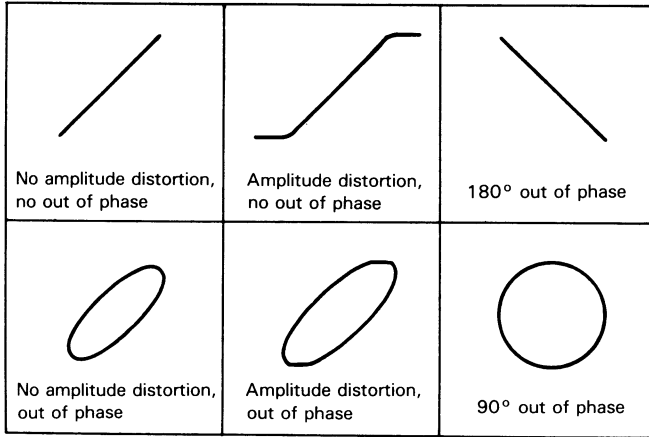


Fig. 26 Typical phase measurement oscilloscope displays

★ Frequency Measurement

1. Connect the sine wave of known frequency to the channel 2 INPUT jack of the oscilloscope and select X-Y operation. This provides external horizontal input.
2. Connect the vertical input probe (CH1 INPUT) to the unknown frequency.
3. Adjust the channel 1 and 2 size controls for convenient, easy-to-read size of display.
4. The resulting pattern, called a Lissajous pattern, shows the ratio between the two frequencies.

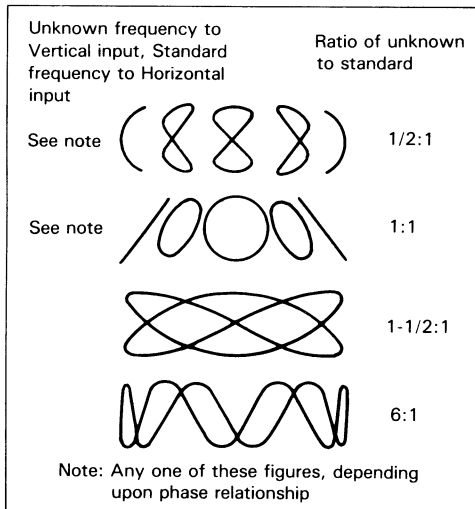


Fig. 27 Lissajous waveforms used for frequency measurement

CS-1020, 1010

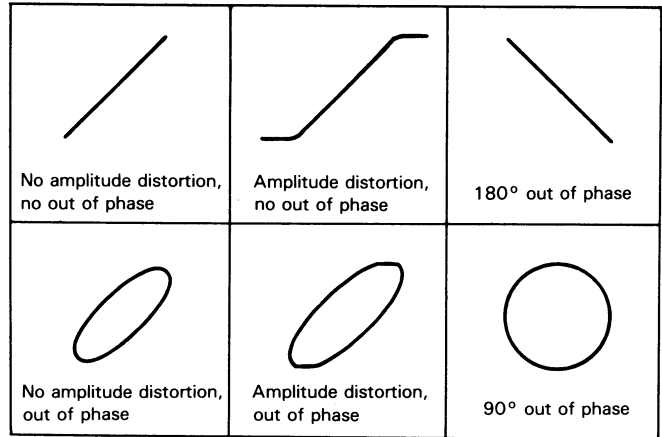


Fig. 26 Typical phase measurement oscilloscope displays

★ Frequency Measurement

1. Connect the sine wave of known frequency to the EXT TRIG INPUT jack of the oscilloscope and set the TRIG MODE switch to X-Y. This provides X-Y operation.
2. Connect the vertical input probe to the unknown frequency.
3. Adjust the vertical and horizontal size controls for a convenient, easy-to-read size of display.
4. The resulting pattern, called a Lissajous pattern, shows the ratio between the two frequencies.

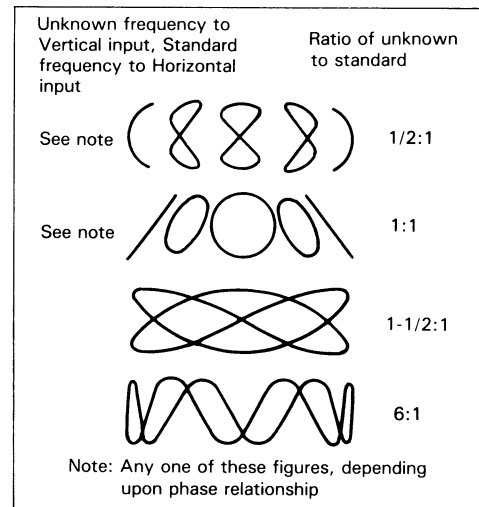


Fig. 27 Lissajous waveforms used for frequency measurement

ACCESSORIES

STANDARD ACCESSORIES INCLUDED

Probe (PC-20)	Y87-1840-00
Attenuation.....	1/10, 1/1
Input Impedance	
1/10	10 M Ω , 18pF or less
1/1	1 M Ω , 100pF or less
Instruction Manual.....	B50-7570-00
Replacement Fuse	
0.8 A	F05-8015-05
0.5 A	F05-5022-05

OPTIONAL ACCESSORIES

Probe Pouch (MC-78).....	Y87-1600-00
--------------------------	-------------

MOUNTING THE PROBE POUCH (MC-78)

This soft vinyl pouch attaches to the right side of the oscilloscope housing and provides storage space for two probes and the operators manual. Install the probe pouch as follows:

1. Unsnap the probe pouch from the retainer plate.
2. Align the retainer plate with the 4 holes on the right side of the case, with the 3 snaps at the top.
3. Attach the four corners of the retainer plate to the oscilloscope case with the four nylon rivets supplied.
4. Attach the probe pouch to the retainer plate using the snap fastener.

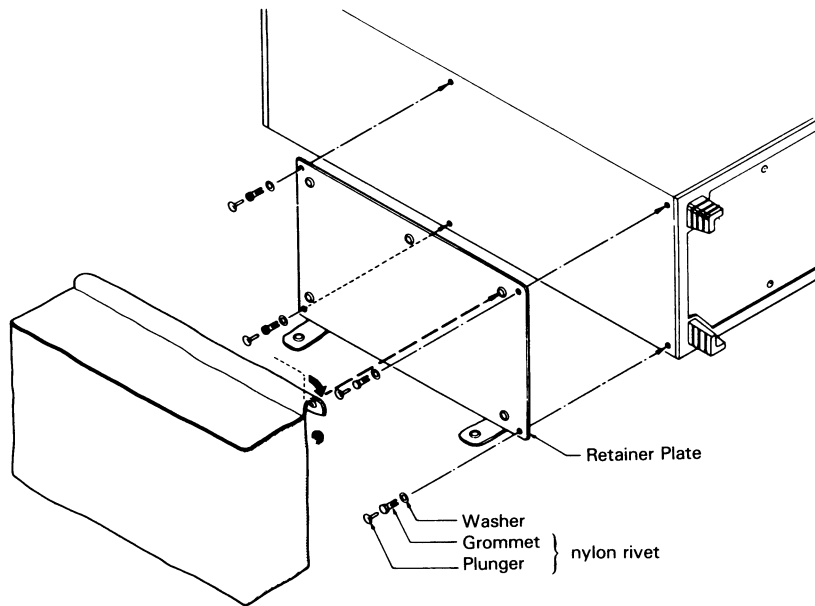


Fig. 28

A product of
TRIO-KENWOOD CORPORATION
17-5, 2-chome, Shibuya, Shibuya-ku, Tokyo 150, Japan

manual produced by

ElectronicsAndBooks@Yahoo.com

PO Box 5156

2000 GD Haarlem

Netherlands

manual produced by

ElectronicsAndBooks@Yahoo.com

PO Box 5156

2000 GD Haarlem

Netherlands